

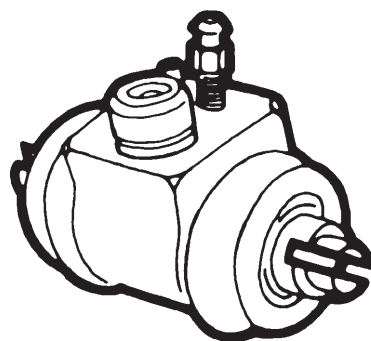

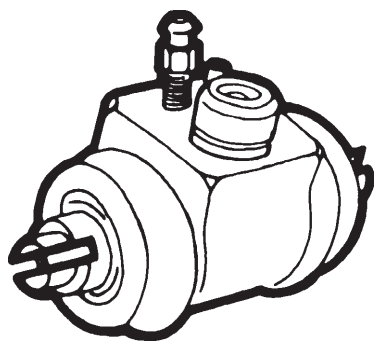

RADBREMSZYLINDER & REPARATURSÄTZE



**BRUGSVEJLEDNING OG INDHOLDSFORTEGNELSE
DIRECTIONS FOR USE AND CONTENTS
BESTELLHINWEISE UND INHALTSVERZEICHNIS**

80.... HJULCYLINDER WHEELCYLINDER RADZYLINDER
87.... REPARATIONSSÆT REPAIR KIT REPARATURSATZ

	GRUPPE NR. GROUP NO. GRUPPE NR.	SIDE PAGE SEITE		GRUPPE NR. GROUP NO. GRUPPE NR.	SIDE PAGE SEITE
ALFA ROMEO	10	5	MITSUBISHI	30	41
AUDI	47	6	NISSAN	22	43
AUTOBIANCHI	23	9	OPEL	36	46
BARKAS	59	9	PEUGEOT	37	51
BEDFORD	14	9	PORSCHE	56	54
BMW	15	10	RENAULT	39	55
CITROEN	19	13	ROVER GROUP	40	60
DACIA	39	17	AUSTIN		
DAEWO	50	17	LEYLAND		
DAIHATSU	51	18	TRIUMPH		
FIAT	23	19	SAAB	41	62
FORD	25	24	SEAT	23	63
FORD USA	25	31	SKODA	43	64
HANOMAG	28	31	SUBARU	44	64
HONDA	26	32	SUZUKI	52	64
HYUNDAI	34	34	TALBOT	18	65
ISUZU	14	35	TOYOTA	45	66
KIA	35	35	TRABANT	58	69
LADA	23	36	VAUXHALL	36	69
LANCIA	23	36	VW VAG	47	72
MAZDA	32	38	VOLVO	48	77
MERCEDES-BENZ	33	40	WARTBURG	49	79
MCC	33	40	YUGO (ZASTAVA)	23	79
Anvendelsesliste/Buyers guide/Nummerische Liste				Side/Page/Seite	81-92
III. udluftningsskruer/III. Bleeder screws/Abb. Entlüftungsschrauben				Side/Page/Seite	93-94

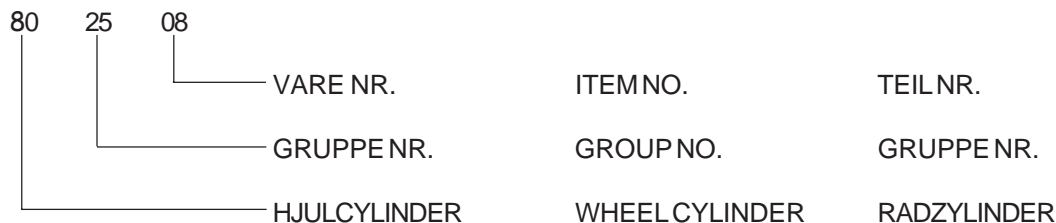

Vi gør opmærksom på, at gruppe nr. kan forekomme indenfor flere bilmærker.
Please notice that group no. can occur in more than one mark.
Bitte beachten Sie, dass diese Artikelnummern bei mehreren Fahrzeuganwendungen verwendet wird.

FORKORTELSER	ABBREVIATIONS	ABKÜRZUNGEN
B: Bag	Rear	hinten
F: For	Front	vorne
U: Udgår	Available only while stock last	entfällt

HENVISNINGER	NOTEKEY	HINWEISE
1 : Uden udligningsventil	Without brake pressure valve	ohne Bremskraftregler
2 : Med udligningsventil	With brake pressure valve	mit Bremskraftregler
3 : Justerhus	Adjuster	Nachstellung
4 : Bendix bremsler for	Bendix front brakes	VA Bendix Bremsen
5 : Citroën bremsler for	Citroën front brakes	VA Citroën Bremsen
6 : Med indbygget reguleringsventil	With adjustment valve	mit integriertem Regler
7 : Uden indbygget reguleringsventil	Without adjustment valve	ohne integriertem Regler
8 : Med mm. gevind	With mm. thread	mit mm. Gewinde
9 : Med tvilling montering	With dual tires	mit Doppelbereifung
10 : Med bremsetromler for	Front drum brakes	Trommelbremsen vorne
11 : Med " gevind	With " thread	mit " Gewinde
12 : Hjulafstand 2950 mm.	Wheelbase 2950 mm.	Radstand 2950 mm.
13 : Hjulafstand 3650 mm.	Wheelbase 3650 mm.	Radstand 3650 mm.
14 : 1 Kreds	Single line	Einkreisanlage
15 : Med selvjustering	With self adjustment	mit Selbstnachstellung
16 : Med forstærket chassis	With HD suspension	mit verstärktem Fahrwerk
17 : Med forstærkede bremsler	With HD brakes	mit verstärktem Bremse
18 : Aluminium	Aluminium	Aluminium
B : Belgien	Belgium	Belgien
CH : Schweiz	Switzerland	Schweiz
DK : Danmark	Denmark	Dänemark
F : Frankrig	France	Frankreich
N : Norge	Norway	Norwegen
NL : Holland	Holland	Holland
S : Sverige	Sweden	Schweden
SF : Finland	Finland	Finnland
UK : Storbritanien	Great Britain	Groß Britannien

Dette katalog er udarbejdet med største omhyggelighed, dog kan vi ikke påtage os ansvar for eventuelle fejl. Bilfabrikanters og andre reservedelsnumre er kun nævnt som reference.

Every effort has been made to ensure that the information in this catalogue is correct. However we cannot accept any responsibility for errors which may occur. Vehicle manufacturers and component suppliers part numbers are listed for information only.

Alle Angaben in diesem Katalog sind mit größter Sorgfalt erstellt worden, jedoch können Ersatzansprüche auf Grund evt. Fehlangaben nicht anerkannt werden. Die verwendeten Original-Nummern der Fahrzeug-Herstellern dienen ausschließlich Vergleichszwecken.

Garanti

Garantien dækker almindelig ombytning af den defekte del, når NK har godkendt fejlen. Den defekte del må indsendes franko og reklamationer må være ledsaget af en udfyldt rapport, for at blive behandlet.

Copyright

Mekanisk, fotografisk eller anden gengivelse af dette katalog eller dele heraf er ikke tilladt.

Alle rettigheder forbeholdes.

Guarantee and compensation

The guarantee covers usual replacement of the defect part, following approval by NK of the defect. The defect part must be forwarded to us carriage paid, and a duly prepared report of the complaint must be enclosed to receive our attention.

Copyright

All rights reserved. No part of this catalogue may be reproduced, stored in a retrieval system or transmitted, in any form or by any means, electronic, mechanical, photocopying, recording or otherwise.

Information in this catalogue are subject to alteration.

Gewährleistung

Unsere Haftung für mangelhafte Ware, Bearbeitung, Montage oder andere Mängel beschränkt sich auf den Ersatz der von NK als fehlerhaft anerkannten Ware. Mit jeder Meldung eines Mangels ist uns franko die beanstandete Ware zur Prüfung zur Verfügung zu stellen. Geschieht das nicht, entfallen alle Mängelansprüche.

Copyright

Wir behalten uns alle Rechte vor. Vervielfältigung oder Mitbenutzung dieses Kataloges - auch auszugsweise - für die Erstellung eines Eigenkataloges ist ohne Zustimmung unzulässig.

Katalogangaben sind ohne Gewähr.

© NK 2004

NK varenumre der ikke fremtræder i prislisen kan være under udarbejdelse. Ring og forhør.

NK Nos. which are not in the price list might be in course of preparation. Please call and ask.

NK Nr., die nicht in der Preisliste sind, können in Ausarbeitung sein. Bitte anrufen und erfragen.





F/B

∅

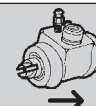
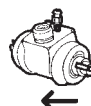

ALFA ROMEO

33

1.2/1.3/1.5 Berline	7/83-8/86	BEN	B	17,4	801002	801001
1.2/1.3/1.5 Berline	9/86-12/89	BEN	B	17,4	801005	801006
1.4/1.4 i.e./1.5 i.e. Berline	89-9/94	BEN	B	17,4	801005	801006
1.4/1.5 Sport Wagon	9/85-12/89	BEN	B	17,4	801005	801006
1.4 i.e./1.5 i.e. Sport Wagon	1/90-9/94	BEN	B	17,4	801005	801006
1.5 4x4	85-89	BEN	B	19,0	801007 U	801007 U
1.7 i.e.	8/87-89	BEN	B	17,4	801005	801006
1.7 i.e./1.7 16V, Berline, (-ABS)	1/90-9/94	BEN	B	17,4	801005	801006
1.7 i.e./1.7 16V, Sport Wagon, (-ABS)	1/90-9/94	BEN	B	17,4	801005	801006
1.7 16V 4x4, (-ABS)	1/90-9/94	BEN	B	17,4	801005	801006
Super 1.8 TD 4x2	9/86-	BEN	B	17,4	801005	801006
Super 1.8 TD Break	8/87-88	BEN	B	17,4	801005	801006

145

1.4 i.e./1.6 i.e./1.9 JTD	9/94-1/01		B	20,6	802343	802343
1.4/1.6/1.8 i.e 16V T.S/1.9 TD/2.0 16V Quadri, (-ABS)	10/94-1/01		B	22,2	802338	802338

146

1.4 i.e./1.6 i.e./1.9 JTD	12/94-1/01		B	20,6	802343	802343
1.4/1.6/1.8 i.e 16V T.S/1.9 TD/2.0 16V Quadri, (-ABS)	12/94-1/01		B	22,2	802338	802338

AR 6

1.9 D/2.4 D/2.4 TD/2.5 D	9/86-12/89	LUC	B	25,4	809936	809936
--------------------------	------------	-----	---	------	---------------	---------------

Arna

1.2/1.3/1.5 Ti	84-86	BEN	B	19,0	801007 U	801007 U
----------------	-------	-----	---	------	-----------------	-----------------



F/B

Ø

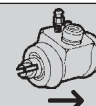
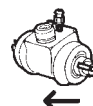

AUDI

A2 (8Z0)

1.2 TDI/1.4/1.4 Tdi (18)

2/00-

ATE

B

17,4

804739

804739

Coupe

1.6

2/81-8/81

ATE

B

14,3

804701

804701

1.6 Aut.

2/81-8/81

ATE

B

15,8

804709

804709

1.8

8/81-7/84

ATE

B

14,3

804701

804701

1.8

8/84-7/88

ATE

B

15,8

804709

804709

1.8 Aut.

8/81-7/84

ATE

B

15,8

804709

804709

1.9

10/80-8/83

ATE

B

15,8

804709

804709

2.0i

9/83-7/87

ATE

B

17,4

804706

804706

2.2i

2/81-7/88

ATE

B

17,4

804706

804706

50

Alle/All (1)

8/74-7/78

ATE

B

14,3

804701

804701

Alle/All (2)

8/74-7/78

ATE

B

17,4

804706

804706

80

1.3

8/74-3/87

ATE

B

14,3

804701

804701

1.5

72-7/74

ATE

B

15,8

804707 U

1.5 (1)

8/74-8/75

ATE

B

14,3

804701

804701

1.5 (2)

8/74-8/75

ATE

B

17,4

804706

804706

1.5 Aut.

8/74-8/75

ATE

B

17,4

804706

804706

80

1.6

9/75-8/86

ATE

B

14,3

804701

804701

1.6 51 kW.

9/86-7/91

ATE

B

15,8

804709

804709

1.6 51 kW.

9/86-7/91

LUC

B

19,0

804735

804735

1.6 51 kW, (-ABS)

1/92-

ATE

B

17,4

804706

804706

1.6 55 kW.

8/89-7/91

ATE

B

15,8

804709

804709

1.6 73 kW., (-ABS)

3/92-7/92

LUC

B

19,0

804735

804735

1.6 73 kW., (-ABS)

8/92-

B

20,6

804736

804736

1.6i CH. ->8452040209

9/73-

ATE

B

15,8

804707 U

1.6i CH. 8452040210->

-9/79

ATE

B

17,4

804706

804706

1.6i

10/79-7/82

ATE

B

15,8

804709

804709

1.6 Aut.

9/75-9/79

ATE

B

17,4

804706

804706

1.6 Aut.

10/79-8/86

ATE

B

15,8

804709

804709

1.6 Diesel

8/80-7/81

ATE

B

15,8

804709

804709

1.6 Diesel

8/81-8/86

ATE

B

14,3

804701

804701

1.6 Diesel

2/87-7/89

ATE

B

15,8

804709

804709

1.6 Diesel Aut.

8/80-8/86

ATE

B

15,8

804709

804709



F/B

∅

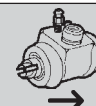
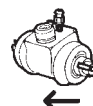

AUDI

80

1.6 Turbo-Diesel	8/81-8/86	ATE	B	15,8	804709	804709
1.6 Turbo-Diesel	4/88-7/91	LUC	B	19,0	804735	804735
1.6/1.9 TDi/2.0/2.0 16V (+ Avant), (Aluminium) (18)	9/91-1/96	FAG	B	20,6	804738	804738
1.6 Kombi	1/75-8/78	ATE	B	17,4	804706	804706
1.8	8/82-8/86	ATE	B	14,3	804701	804701
1.8 Aut.	8/82-8/86	ATE	B	15,8	804709	804709
1.8 Aut. 55 kW	9/86-7/91	LUC	B	19,0	804735	804735
1.8 Variomatic 55 kW	10/86-7/89	ATE	B	15,8	804709	804709
1.8 55 kW	8/89-7/91	ATE	B	15,8	804709	804709
1.8 66 kW	9/86-7/91	LUC	B	19,0	804735	804735
1.8i	11/82-8/86	ATE	B	15,8	804709	804709
1.9	8/81-7/83	ATE	B	15,8	804709	804709
1.9 Diesel	8/89-7/91	LUC	B	19,0	804735	804735
1.9 Turbo-Diesel 55 kW, (-ABS)	9/91-9/92	ATE	B	17,4	804706	804706
1.9 Turbo-Diesel 66 kW, (-ABS)	9/91-7/92	LUC	B	19,0	804735	804735
1.9 Turbo-Diesel 66 kW, (-ABS)	8/92-		B	20,6	804736	804736
2.0	8/83-7/84	ATE	B	15,8	804709	804709
2.0 66 kW, (-ABS)	9/91-7/92	LUC	B	19,0	804735	804735
2.0 66 kW, (-ABS)	8/92-		B	20,6	804736	804736

90

1.6 Turbo-Diesel	4/88-7/91	LUC	B	19,0	804735	804735
1.8	8/89-7/91	LUC	B	19,0	804735	804735
All/Alle (- 100 kW)	10/84-3/87	ATE	B	17,4	804706	804706

100

1.6	8/76-7/82	ATE	B	15,8	804709	804709
1.6, (-ABS)	3/92-7/93		B	20,6	804736	804736
1.8	8/82-12/90	ATE	B	17,4	804706	804706
1.9	8/80-7/84	ATE	B	17,4	804706	804706
2.0	6/76-7/78	ATE	B	17,4	804706	804706
2.0	8/84-12/90	ATE	B	17,4	804706	804706
2.0	12/90-7/93		B	20,6	804736	804736
2.0 Diesel	10/78-7/82	ATE	B	17,4	804706	804706
2.0 Diesel	9/86-12/90	ATE	B	17,4	804706	804706
2.0 Turbo-diesel	3/82-12/90	ATE	B	17,4	804706	804706
2.2	3/77-9/86	ATE	B	17,4	804706	804706



F/B

∅

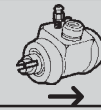
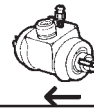

AUDI

80
2.4 Diesel

8/89-7/93

B

20,6

804736

804736



F/B

Ø

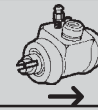
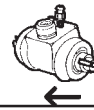

AUTOBIANCHI

A 112

Alle/All

71-12/85

O.E

B

19,0

802304

802304

Y 10

Alle/All

3/85-

B

19,0

802328

802328

BARKAS

B 1000

Alle/All

4/67-12/91

F

31,8

805901 U

805901 U

Alle/All

4/67-12/91

B

25,4

805903 U

805903 U

BEDFORD

CF Van

220 18 cwt

77-

LCH

F

22,0

809925 U

809925 U

25/35 cwt.

69-77

LCH

F

22,0

809928

809925 U

25/35 cwt.

69-77

LCH

B

15,7

809928

809928

250 22 cwt/250 1300 kg./280 25 cwt

77-

LCH

F

23,8

801409

801410 U

250 22 cwt/250 1300 kg./280 25 cwt

77-

LCH

B

15,7

809928

809928

340 35 cwt/350 3500 kg.

77-

LCH

F

22,0

809928

809925 U

340 35 cwt/350 3500 kg.

77-

LCH

B

15,7

809928

809928



F/B

Ø

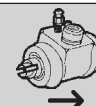
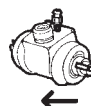

BMW

02 Series(E10)

1502 (-S)	1/75-7/77	ATE	B	15,8	801504	801504	
1600 Ti & 1600/2	9/67-11/69	ATE	B	15,8	801504	801504	
1602 (-S)	71-75	ATE	B	17,4	801503 U	801503 U	
1802 (-S)	71-75	ATE	B	15,8	801504	801504	
2002 Exc. Ti/Tii/Turbo (-S)	68-75	ATE	B	15,8	801504	801504	
2002 Turbo (-S)	1/74-7/75	ATE	B	22,2	801502 U	801502 U	

02 Series (E10)

1600-2 Cabriolet	66-71	ATE	B	17,4	801503 U	801503 U	
2002 Ti/Tii (- Turbo) (-S) Cabriolet	69-75	ATE	B	17,4	801503 U	801503 U	

02 Series Touring (E6)

1600	71-73	ATE	B	17,4	801503 U	801503 U	
1802	73-75	ATE	B	15,8	801504	801504	
2002 & 2002 Tii	5/71-7/75	ATE	B	15,8	801504	801504	

1500-2000 Series

2000 Tii	69-75	ATE	B	17,4	801503 U	801503 U	
2000 Touring (- Tii)	69-73	ATE	B	15,8	801504	801504	

2000-3.2 (E9)

2800 CS Coupe	70-72	ATE	B	22,2	801502 U	801502 U	
---------------	-------	-----	---	------	-----------------	-----------------	--

3 Series (E21)

315/316/318/318i/320/320-6/320i	6/75-3/84	ATE	B	19,0	809914	809914	
---------------------------------	-----------	-----	---	------	---------------	---------------	--

3 Series (E30)

315	9/82-10/83	ATE	B	19,0	809914	809914	
316 & 318	3/82-9/86	LUC	B	20,6	801506	801506	871510 U
316 & 318	10/86-91	LUC	B	22,2	801508	801508	
320 i	9/82-91	LUC	B	20,6	801506	801506	871510 U
324 d & 324 td	9/85-91	LUC	B	22,2	801508	801508	

3 Series Cabriolet (E30)

318 i	9/90-10/93	LUC	B	22,2	801508	801508	
320 i	4/86-10/93	LUC	B	20,6	801506	801506	

3 Series Touring (E30)

316 i & 318 i	4/89-6/94	LUC	B	22,2	801508	801508	
320 i	1/98-12/91	LUC	B	20,6	801506	801506	



F/B

∅

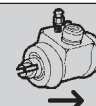
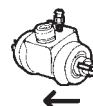

BMW

3 Series (E36)

316 i	9/90-2/98	LUC	B	23,8	801510	801510
316 i Compact	3/94-8/00	LUC	B	22,2	801511	801511
316 i Coupe	9/93-4/99	LUC	B	23,8	801510	801510
318 i/318 is/318 ti Compact	12/90-8/00	LUC	B	23,8	801510	801510
318 is Coupe	3/92-4/99	LUC	B	23,8	801510	801510
318 tds	1/95-2/98	LUC	B	23,8	801510	801510
318 tds Compact	1/95-8/00	LUC	B	22,2	801511	801511

3 Series Touring (E36)

316 i & 318 i	7/95-10/99	LUC	B	23,8	801510	801510
---------------	------------	-----	---	------	---------------	---------------

5 Series (E12)

518/520/520 i & 520/6	6/72-5/81	ATE	B	22,2	801502 U	801502 U
-----------------------	-----------	-----	---	------	-----------------	-----------------

5 Series (E28)

518/518 i, (-ABS)	6/81-12/87	ATE	B	19,0	809914	809914
520 i, (-ABS)	4/81-8/84	ATE	B	19,0	809914	809914
520 i, (-ABS)	9/84-6/90	ATE	B	20,6	801507	801507
524 td, (-ABS)	11/82-8/84	ATE	B	19,0	809914	809914
524 td, (-ABS)	9/84-3/86	ATE	B	20,6	801507	801507

5 Series (E34)

518 i, (-ABS)	8/89-9/95	ATE	B	23,8	801509	801509
---------------	-----------	-----	---	------	---------------	---------------



F/B

∅

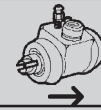
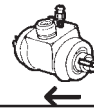

CHRYSLER

Voyager I

Alle/All

8/84-1/95

B

19,0

809302

809302

Voyager II

Alle/All

1/95-3/01

B

17,5

809301

809301

Voyager II

Alle/All

1/95-3/01

B

19,0

809304

809304



F/B

Ø

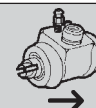
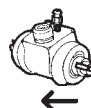

CITROËN

2 CV

4 & 6

6/70-

BEN

F

28,6

801909

801909

4 & 6

6/70-

BEN

B

17,4

801910 U

801910 U

6 (LHM)

7/81-

BEN

B

16,0

801911

801911

AMI & AMI Break

8

7/69-12/77

BEN

B

16,0

801911

801911

AX

Alle/All (6)

9/86-12/98

BEN

B

19,0

801919

801920

Alle/All (7)

9/86-12/98

BEN

B

19,0

801921

801921

1.4 Gti (180mm. Tromle/Drum/Trommel)

5/91-12/96

BEN

B

19,0

809957

809958

1.4 GTi/1.4D/1.4 4x4, ABS

5/91-12/96

B

19,0

801931

801931

Berlingo

Alle/All

7/96-

LUC

B

22,2

801929

801929

C 2

Alle/All

9/03-

B

20,6

803755

803755

C 3

Alle/All, (-ABS)

02/02-

LUC

B

19,0

801933

801934

Alle/All, ABS

02/02-

LUC

B

20,6

801935

801935

C 15

Alle/All

10/84-12/97

BEN

B

22,0

809943

809943

C 25

Alle/All (- 800 Kg. & 1800 Kg.) CH. ->73500

10/81-12/82

LUC

B

22,2

809944 U

809944 U

Alle/All (- 800 Kg. & 1800 Kg.) CH. 73501->

1/83-94

LUC

B

25,4

809936

809936

Alle/All 800 Kg.

2/89-94

LUC

B

22,2

801928

801928

Alle/All 1800 Kg.

87-94

LUC

B

27,4

809955

809955

Dyane

4 & 6

6/70-12/80

BEN

F

28,6

801909

801909

4 & 6

6/70-12/80

BEN

B

17,4

801910 U

801910 U

6

8/80-10/84

BEN

B

16,0

801911

801911

Evasion

Alle/All

6/94-7/02

BEN

B

19,0

801926

801926

Jumper

Alle/All 1000 Kg.

2/94-4/02

LUC

B

25,4

802340

802340

Alle/All 1400 Kg. (-2.5 TD)

2/94-4/02

LUC

B

25,4

802340

802340

2.5 TD 1400 Kg.

2/94-4/02

LUC

B

27,0

802341

802341

Alle/All 1800 Kg.

2/94-4/02

LUC

B

28,6

802342

802342



F/B

Ø

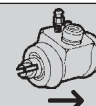
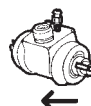

CITROËN

Jumpy

Alle/All

10/95-

BEN

B

19,0

801926

801926

LN

0.6

9/77-7/79

BEN

B

22,0

809911

809911

0.6

7/76-8/77

LUC

B

22,2

809932

809933

0.6

9/77-7/79

LUC

B

22,2

809935

809935

LNA

0.6 (4)

11/78-

BEN

B

22,0

809911

809911

0.6 (5)

11/78-

BEN

B

20,6

809910

809910

0.6

11/78-6/82

LUC

B

20,6

801918

801918

0.6

11/78-6/82

LUC

B

22,2

809935

809935

11 E/RE 1124 cc.

7/82-

BEN

B

20,6

809910

809910

11 RE

7/82-7/85

LUC

B

20,6

801918

801918

Mehari

Alle/All

1/72-7/77

BEN

F

28,6

801909

801909

Alle/All

1/72-7/77

BEN

B

17,4

801910 U

801910 U

Alle/All

7/78-

BEN

B

16,0

801911

801911

Saxo

1.0 & 1.1 (165 mm. Tromle/Drum/Trommel)

3/96-

BEN

B

19,0

803747

803748

1.1 (180 mm. Tromle/Drum/Trommel), ABS

3/96-

BEN

B

19,0

809957

809958

1.1 (180 mm. Tromle/Drum/Trommel), ABS

3/96-

LUC

B

20,6

801930

801930

CH. ->8095

1.1 (180 mm. Tromle/Drum/Trommel), ABS

3/96-

LUC

B

20,6

803755

803755

CH. 8096->

1.4/1.5 D & 1.6

3/96-

BEN

B

19,0

809957

809958

1.4/1.5 D & 1.6

3/96-

LUC

B

20,6

801930

801930

Visa

4ch 652 cc. (4)

9/78-3/91

BEN

B

22,0

809911

809911

4ch 652 cc. (5)

7/82-3/91

BEN

B

20,6

809910

809910

4ch 652 cc.

9/78-3/91

LUC

B

20,6

801918

801918

4ch 652 cc.

9/78-3/91

LUC

B

22,2

809935

809935

5ch 1124 cc. (4)

9/78-7/82

BEN

B

22,0

809911

809911

5ch 1124 cc. (5)

9/78-7/82

BEN

B

20,6

809910

809910

5ch 1124 cc.

9/78-

LUC

B

20,6

801918

801918

5ch 1124 cc.

9/78-

LUC

B

22,2

809935

809935

7ch 1219/1360 cc.

9/80-7/82

BEN

B

20,6

809910

809910

10E 954 cc.

11/83-

BEN

B

22,0

809911

809911

11E/RE 1124 cc.

7/83-

BEN

B

22,0

809911

809911

1219 cc.

9/80-6/82

LUC

B

22,2

809935

809935



F/B

Ø

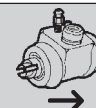
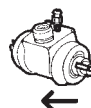

CITROËN

Visa

1360 cc.	3/82-	LUC	B	22,2	809935	809935
14 TRS 1360 cc.	7/84-	BEN	B	22,0	809911	809911
14 TRS 1360 cc.	7/84-	LUC	B	22,2	809935	809935
Chrono XT 1360 cc.	7/82-	BEN	B	22,0	809911	809911
GT 1360 cc.	7/82-7/86	BEN	B	22,0	809911	809911
GTi & Diesel	84-89	BEN	B	22,2	801925	801925
L Super E	7/82-7/83	BEN	B	22,0	809911	809911

Xsara

1.4/1.6/1.8/1.8 D/1.9 D, (-ABS) (6)	9/97-	BEN	B	20,6	803929	803930
1.4/1.6/1.8/1.9 D/1.9 TD/2.0 Hdi, ABS	9/97-	LUC	B	20,6	801930	801930
Coupe 1.8 Aut., (-ABS) (6)	2/98-8/00	BEN	B	20,6	803929	803930
Coupe 1.8 Aut., (-ABS) (6)	2/98-8/00	LUC	B	20,6	809949	809950
Coupe 1.8 Aut., ABS CH. ->08210	2/98-	LUC	B	20,6	801930	801930
Coupe 1.8 Aut., ABS CH. 08211->	-8/00	LUC	B	20,6	803755	803755
Coupe 1.9 TD, (-ABS)	2/98-9/00	LUC	B	20,6	801930	801930
Coupe 1.9 TD, ABS CH. ->08210	2/98-	LUC	B	20,6	801930	801930
Coupe 1.9 TD, ABS CH. 08211->	-9/00	LUC	B	20,6	803755	803755
Picasso 1.6/1.8 16V/2.0 Hdi	01/00-	LUC	B	22,2	801929	801929
Weekend 1.4/1.6/1.8 D/1.9 D/2.0 Hdi,	10/97-	BOS	B	20,6	801927	801927
Weekend 1.4/1.6/1.8, ABS	10/97-	BOS	B	22,0	801932	801932
Weekend 1.5 D/1.8 D/1.9 D/1.9 TD, ABS	10/97-	BOS	B	22,0	801932	801932

ZX

1.1/1.4/1.6/1.8, (-ABS)	3/91-8/92	BEN	B	20,6	801923	801924
1.1/1.4/1.6/1.8, (-ABS) (6)	9/92-	BEN	B	20,6	803929	803930
1.1/1.4/1.6/1.8, (-ABS) CH. ->5718 (6)	3/91-8/92	LUC	B	20,6	809947	809948
1.1/1.4/1.6/1.8, (-ABS) CH. 5719-> (6)	9/92-	LUC	B	20,6	809949	809950
1.4/1.6/1.8, ABS	7/95-	LUC	B	20,6	801930	801930
1.4/1.6/1.8 Break, ABS	2/94-	BOS	B	20,6	801927	801927
1.4/1.6/1.8 Break, ABS	7/95-	LUC	B	20,6	801930	801930
1.9 Diesel, (-ABS)	3/91-8/92	BEN	B	20,6	801923	801924
1.9 Diesel, (-ABS) (6)	9/92-	BEN	B	20,6	803929	803930
1.9 Diesel, (-ABS) CH. ->5718 (6)	3/91-8/92	LUC	B	20,6	809947	809948
1.9 Diesel (6)	9/92-	LUC	B	20,6	809949	809950
1.9 Diesel, ABS	7/95-	LUC	B	20,6	801930	801930
1.9 Diesel Break, ABS	7/95-	BOS	B	20,6	801927	801927



F/B

∅

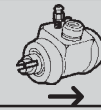
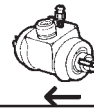

CITROËN

ZX

1.9 Turbo-Diesel, (-ABS) (6)	1/93-	BEN	B	20,6	803929	803930
1.9 Turbo-Diesel, (-ABS) (6)	9/92-	LUC	B	20,6	809949	809950
1.9 Turbo-Diesel, ABS	7/95-	LUC	B	20,6	801930	801930
1.9 Turbo-Diesel Break, ABS	7/95-	LUC	B	20,6	801930	801930



F/B

∅

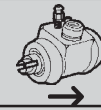
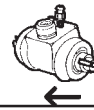

DACIA

1310

1.3

5/83-

BEN

B

803910 U

DAEWOO

Espero

Alle/All

2/95-

ATE

B

19,0

803629

803629

Lanos

1.4

5/97-

O.E

B

17,4

803628

803628

1.5 CH. ->447433

5/97-

O.E

B

17,4

803628

803628

1.5 CH. 447434->

5/97-

ATE

B

19,0

803629

803629

1.6 16V

5/97-

ATE

B

19,0

803629

803629

Matiz

Alle/All

9/98-

B

17,4

805001

805001

Nexia

Alle/All

2/95-

ATE

B

19,0

803629

803629

Nubira

1.6

97-

O.E

B

20,6

803643

803643



F/B

∅

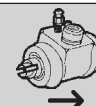
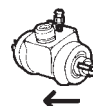

DAIHATSU

Charade (G10)

Alle/All

78-4/83

O.E

B

15,8

805102

805101

Charade (G 100)

Alle/All

2/87-

O.E

B

17,4

805105

805106

Charade (G 101)

Alle/All

2/87-

O.E

B

17,4

805105

805106

Charade (G 102)

Alle/All

9/88-

O.E

B

17,4

805105

805106

Charade (G 11)

Alle/All

4/83-

O.E

B

15,8

805103

805103

Charade (G 200)

Alle/All

1/93-

O.E

B

17,4

805105

805106

Charade (G 202)

Alle/All

1/93-

O.E

B

17,4

805105

805106

Charade (G 203)

Alle/All

6/94-

O.E

B

17,4

805105

805106

Charade (G 30)

Alle/All

10/82-

O.E

B

15,8

805103

805103

Charmant

1300 A35

11/81-7/87

O.E

B

20,6

809939

809939

1600 A40

11/76-11/81

O.E

B

19,0

809938

809938

1600 A45

12/81-9/84

O.E

B

19,0

809938

809938

1600 A60

8/83-7/87

O.E

B

19,0

809938

809938

Gran Move

Alle/All

10/96-

B

17,4

805108

805109

Hijet

Alle/All

1/96-

B

17,4

805110

805110

Rocky

Alle/All

9/89-

O.E

B

25,4

805107

805107

Terios (J1)

Alle/All

10/97-

B

20,6

805111

805112



F/B

∅

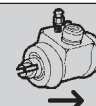
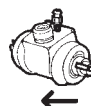

FIAT

126

Alle/All

73-96

O.E

B

19,0

802304

802304

127

Alle/All

3/71-10/82

O.E

B

19,0

802304

802304

Alle/All

10/82-86

O.E

B

19,0

802328

802328

Panorama/Diesel (147 Brazil) (11)

10/82-

O.E

B

19,0

802328

802328

128

Alle/All

69-84

O.E

B

19,0

802304

802304

131

Alle/All

10/74-8/82

O.E

B

22,2

802313 U

802313 U

132

Alle/All

4/77-81

O.E

B

22,2

802313 U

802313 U

147

Alle/All

10/76-9/82

O.E

B

19,0

802304

802304

Alle/All

10/82-

O.E

B

19,0

802328

802328

500

0.5/0.6

3/65-72

O.E

B

19,0

802304

802304

600

0.6/0.8 (D)

3/55-2/71

O.E

F

22,2

802304

802303

0.6/0.8 (D)

3/55-2/71

O.E

B

19,0

802304

802304

850

850

3/65-73

O.E

F

22,2

802303

802303

850

3/65-73

O.E

B

19,0

802304

802304

850 Coupe/Special/Spider

66-71

O.E

B

19,0

802304

802304

900

900 T/E Panorama/Pulmino

1/78-1/86

O.E

B

15,8

802324

802324

Brava/Bravo

1.2 16V, (-ABS)

12/98-10/01

LCH

B

22,2

802345

802345

1.4, ABS

6/95-

BEN

B

22,2

802344

802344

1.4

6/95-

LCH

B

22,2

802345

802345

1.6 & 1.8

6/95-

BEN

B

22,2

802344

802344

1.6 & 1.8

6/95-

LCH

B

22,2

802345

802345

1.9 Diesel, ABS

6/95-

BEN

B

22,2

802344

802344

1.9 Diesel

6/95-

LCH

B

22,2

802345

802345

1.9 TD/1.9 JTD

3/96-10/01

BEN

B

22,2

802344

802344

1.9 TD/1.9 JTD

3/96-10/01

LCH

B

22,2

802345

802345



F/B

∅

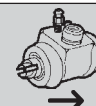
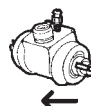

FIAT

Cinquecento

Alle/All

92-

BEN

B

19,0

802328

802328

Daily I

28 F/28-8/30 F/30-8/32-8

1/78-4/99

B

15,9

802352

802352

35-8

1/78-4/99

B

15,9

802352

802352

35-8

1/78-4/99

B

17,5

802323

802323

35-9/35-10/40-8/40-10/40-12

1/78-4/99

B

17,5

802323

802323

35-10 Turbo/35-12 Turbo/40-10 Turbo

1/78-4/99

B

19,0

802530

802530

45-12

6/90-4/99

B

15,9

802352

802352

45-12

6/90-4/99

B

17,5

802323

802323

Doblo

Alle/All

3/01-

ATE

B

20,6

802348

802348

Ducato (280/290)

Alle/All 900-1600 Kg.

1/82-3/94

LUC

B

22,2

809944 U

809944 U

Alle/All 900-1600 Kg.

1/82-3/94

LUC

B

25,4

809936

809936

Alle/All 1800 Kg.

1/82-3/94

LUC

B

26,9

809955

809955

Ducato (230)

Alle/All 1000 Kg.

3/94-4/02

LUC

B

25,4

802340

802340

Alle/All 1400 Kg.

3/94-4/02

LUC

B

27,0

802341

802341

Alle/All 1800 Kg.

3/94-4/02

LUC

B

28,6

802342

802342

Ducato (244)

Alle/All

4/02-

LUC

B

27,0

802341

802341

Duna

Alle/All

1/87-12/91

O.E

B

19,0

802328

802328

Fiorino (147)

856/903/1050 cc

11/77-10/82

O.E

B

19,0

802304

802304

903/1050 cc.

10/82-88

O.E

B

19,0

802328

802328

1050/1.3 Diesel (147 Brazil)

80-88

O.E

B

19,0

802304

802304

1.3 Diesel

2/81-10/82

O.E

B

19,0

802304

802304

1.3 Diesel

10/82-88

O.E

B

19,0

802328

802328

1.7 Diesel

01/88-

BEN

B

19,0

802328

802328

Fiorino (146 Uno)

Alle/All

5/88-12/92

BEN

B

19,0

802328

802328

Alle/All

1/93-

LUC

B

20,6

802349

802349

Marea

1.2 16V & Marea Weekend 1.2 16V

10/98-4/99

LCH

B

22,2

802345

802345

1.4 Weekend

7/96-

BEN

B

22,2

802344

802344

1.4/1.6 & 1.8 Berline

7/96-

BEN

B

22,2

802344

802344

1.6 & 1.8 Weekend

7/96-

BEN

B

20,6

802343

802343



F/B

∅

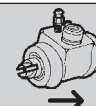
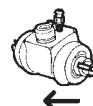

FIAT

Marea

1.9 JTD Berline	4/99-	LCH	B	22,2	802345	802345
1.9 JTD Weekend	4/99-	BEN	B	20,6	802343	802343
1.9 Turbo Diesel Berline	7/96-	BEN	B	22,2	802344	802344
1.9 Turbo Diesel Weekend	7/96-	BEN	B	20,6	802343	802343

Multipla

Alle/All	4/99-	BEN	B	20,6	802343	802343
----------	-------	-----	---	------	---------------	---------------

Palio

Alle/All	4/96-	ATE	B	19,0	802350	802350
----------	-------	-----	---	------	---------------	---------------

Palio (Weekend)

Alle/All	4/96-	BEN	B	20,6	802343	802343
----------	-------	-----	---	------	---------------	---------------

Panda

30/34/45/S	3/80-8/82	O.E	B	15,8	802324	802324
30/34/45/S	9/82-7/84	O.E	B	15,7	802329	802329
30/34/45/S	8/84-85	O.E	B	19,0	802328	802328
45 4x4	7/83-85	O.E	B	19,0	802328	802328
45 4x4	11/85-	O.E	B	19,0	802328	802328
750/900/1000/1100/1300D	11/85-	O.E	B	19,0	802328	802328

Panda (169)

1.1/1.2/1.3 JTD	9/03-	O.E	B	20,6	802353	802353
-----------------	-------	-----	---	------	---------------	---------------

Punto

55/60/75/85/90	9/93-6/00	LCH	B	20,6	802336	802336
55/60/75/85/90/131	9/93-6/00	BEN	B	20,6	802337	802337
Cabrio	4/94-6/00	LCH	B	20,6	802336	802336
Turbo Diesel	9/93-6/00	LCH	B	20,6	802336	802336
Turbo Diesel	9/93-6/00	BEN	B	20,6	802337	802337

Punto II

1.2	9/99-		B	20,6	802346	802346
1.2 16V/1.8 16V/1.4HDi/1.9D/JTD	9/99-	LCH	B	22,0	802347	802347

Punto III (188)

1.4 16V/ 1.9 JTD	7/03-	O.E	B	20,6	802354	802354
------------------	-------	-----	---	------	---------------	---------------

Regata

Alle/All	9/83-6/90	O.E	B	19,0	802328	802328
----------	-----------	-----	---	------	---------------	---------------



F/B

∅

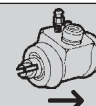
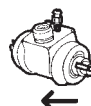

FIAT

Ritmo I

60/65/75 L,CL/85 S

5/78-6/82

O.E

B

17,4

802320 U

802320 U

60/65/75 L,CL/85 S

6/82-11/82

O.E

B

17,4

802331

802331

105 TC

5/81-83

O.E

B

17,4

802320 U

802320 U

125 TC

12/81-83

O.E

B

17,4

802320 U

802320 U

Diesel

5/78-6/82

O.E

B

17,4

802320 U

802320 U

Diesel

6/82-11/82

O.E

B

17,4

802331

802331

Ritmo II

50/60/70/75/85 S

2/83-85

O.E

B

19,0

802328

802328

105/125/130 TC

2/83-85

O.E

B

19,0

802328

802328

Ritmo II

Diesel

2/83-85

O.E

B

19,0

802328

802328

Cabriolet

1/80-7/89

O.E

B

19,0

802328

802328

FL 85

4/85-88

O.E

B

19,0

802328

802328

Scudo

1.6/1.9 D/1.9 TD & 2.0 JTD

7/95-

BEN

B

19,0

801926

801926

Seicento

Alle/All

01/98-

O.E

B

19,0

802328

802328

Siena

Alle/All

4/96-

B

19,0

802351

802351

Talento

1.9 D & 2.0

9/89-

LUC

B

22,2

801928

801928

Tempra

1.4/1.6 Berlina, (-ABS)

11/89-93

BEN

B

19,0

802335

802335

1.4/1.6 Aut.

11/89-93

BEN

B

17,4

802334

802334

1.4/1.6 Break, (-ABS)

4/90-93

BEN

B

17,4

802334

802334

1.4/1.6

3/93-

BEN

B

22,2

802338

802338

1.6 Break (-ABS)

3/93-

BEN

B

22,2

802338

802338

1.6 Break (-ABS)

3/93-

BEN

B

20,6

802343

802343

1.6 Selecta SX

3/93-

BEN

B

20,6

802343

802343

1.8, (-ABS)

11/89-93

BEN

B

17,4

802334

802334

1.8le, (-ABS)

3/93-

BEN

B

20,6

802343

802343

1.9 Diesel DSX, (-ABS)

11/89-93

BEN

B

17,4

802334

802334

1.9 Diesel, (-ABS)

3/93-

BEN

B

22,2

802338

802338

1.9 Turbo-diesel, (-ABS)

11/89-93

BEN

B

17,4

802334

802334

1.9 Turbo-diesel, (-ABS)

3/93-

BEN

B

20,6

802343

802343



F/B

∅

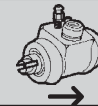
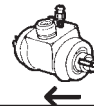

FIAT

Tempra

2.0 ie	10/90-8/96	BEN	B	17,4	802334	802334
2.0 ie 4x4	3/92-3/95	BEN	B	20,6	802343	802343

Tipo

1.1/1.4/1.6	2/88-2/93	BEN	B	15,0	802333	802333
1.4, (-ABS)	3/93-	BEN	B	22,2	802338	802338
1.4 Selecta	2/89-2/93	BEN	B	19,0	802335	802335
1.6 DOHC & 1.6 Selecta	2/88-2/93	BEN	B	17,4	802334	802334
1.6 Man., (-ABS)	3/93-	BEN	B	22,2	802338	802338
1.6 Selecta, (-ABS)	3/93-	BEN	B	20,6	802343	802343
1.7 Diesel	2/88-2/93	BEN	B	19,0	802335	802335
1.7 Diesel & 1.9 Diesel, (-ABS)	3/93-	BEN	B	22,2	802338	802338
1.8ie	4/89-2/93	BEN	B	17,4	802334	802334
1.8, (-ABS)	3/93-	BEN	B	20,6	802343	802343
1.9 Turbo Diesel, (-ABS)	2/88-2/93	BEN	B	17,4	802334	802334
1.9 Turbo Diesel, (-ABS)	3/93-	BEN	B	20,6	802343	802343

2.0 ie	3/90-4/95	BEN	B	17,4	802334	802334
--------	-----------	-----	---	------	---------------	---------------

Ulysse

Alle/All	6/94-8/02	BEN	B	19,0	801926	801926
----------	-----------	-----	---	------	---------------	---------------

Uno

Alle/All	83-95	O.E	B	19,0	802328	802328
----------	-------	-----	---	------	---------------	---------------



F/B

∅

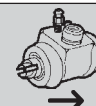
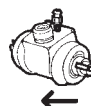

FORD

Capri

1.3 (11)	11/74-12/77	LUC	B	20,6	802516	802516	872512 U
1.6	1/74-10/74	LUC	B	17,4	802518	802518	
1.6/2.0	11/74-6/76	LUC	B	18,0	802522 U	802522 U	
1.6/2.0	7/76-86	LUC	B	17,4	802507	802507	
2.3	11/74-11/84	LUC	B	17,4	802507	802507	
2.8	1/81-86	LUC	B	19,0	809920	809920	
3.0	11/74-7/81	LUC	B	17,4	802507	802507	

Cortina

1300/1600 (+ Estate) MK II	66-70	LUC	B	17,4	802518	802518	
1300/1600 (+ Estate) MK III	70-7/71	LUC	B	20,6	802509	802509	872512 U
1300/1600 (+ Estate) MK III	8/71-74	LUC	B	19,0	802506	802506	
1300/1600 (+ Estate) MK III	74-77	BEN	B	19,0	802508	802508	
2000 (+ Estate) MK III	70-77	LUC	B	17,4	802507	802507	

Escort '81

Express 35/55/Diesel	5/81-	LUC	B	22,2	802513	802513	872561 U
----------------------	-------	-----	---	------	--------	--------	----------

Escort I

1.1/1.3 (10)	1/68-2/76	LUC	F	19,0	809922	809923	
1.1/1.3	1/68-2/76	LUC	B	19,0	809915	809915	
1.1/1.3 (3)	1/68-2/76	LUC	B		899901	899901	

Escort II

1.1/1.3 (8)	12/74-8/80	LUC	B	17,8	802537	802537	
1.1/1.3 (11)	12/74-8/80	LUC	B	20,6	802516	802516	872512 U
1.3 70 HK	12/74-11/75	LUC	B	17,4	802507	802507	
1.3 70 HK	12/75-8/80	LUC	B	19,0	809920	809920	
1.6 RS	1/75-8/80	LUC	B	17,4	802507	802507	
RS 2000	3/73-8/80	LUC	B	19,0	809920	809920	

Escort III

1.1/1.3	9/80-1/83	LUC	B	19,0	802506	802506	
1.1/1.3	2/83-12/85	LUC	B	17,4	802507	802507	
1.1 Turnier/1.3 Turnier	9/80-12/85	LUC	B	22,2	802513	802513	872561 U
1.3/1.6 LX	83-85	LUC	B	17,4	802507	802507	



F/B

∅

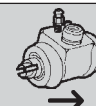
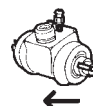

FORD

Escort III

1.6	9/80-1/83	LUC	B	19,0	802506	802506	
1.6	2/83-1/86	LUC	B	17,4	802507	802507	
1.6 Diesel	2/84-12/85	LUC	B	17,4	802507	802507	
1.6 Turnier	9/80-12/85	LUC	B	22,2	802513	802513	872561 U
RS 1600 i	3/82-9/82	LUC	B	19,0	802506	802506	
RS 1600 i	10/82-12/85	LUC	B	17,4	802507	802507	
RS Turbo 1.6	11/84-12/85	LUC	B	17,4	802507	802507	
XR3i 1.6	12/81-9/82	LUC	B	19,0	802506	802506	
XR3i 1.6	10/82-4/83	LUC	B	17,4	802507	802507	
XR3i 1.6	5/83-12/85	LUC	B	17,4	802507	802507	

Escort IV

Alle/All, (-ABS)	2/86-7/90	LUC	B	19,0	802506	802506	
Alle/All, ABS	2/86-7/90	LUC	B	22,2	802513	802513	872561 U
Van & St. car	2/86-7/90	LUC	B	22,2	802513	802513	872561 U

Escort V/VI

1.1/1.3/1.4, (-ABS)	8/90-95	LUC	B	20,6	802552	802552	
1.6/1.8/1.8 Diesel, (-ABS)	8/90-95	LUC	B	19,0	802506	802506	
1.1/1.3/1.4/1.6/1.8 & 1.8D, ABS	8/90-95	LUC	B	22,2	802513	802513	
1.3 St. car, (-ABS)	8/90-95	LUC	B	19,0	802506	802506	
1.4 Cabrio/St. car/Aut., (-ABS)	8/90-95	LUC	B	19,0	802506	802506	

Escort V

1.8 16V XR3i, (-ABS)	2/92-12/92	LUC	B	19,0	802506	802506	
----------------------	------------	-----	---	------	--------	--------	--

Escort VII

1.3/1.4GLX, GT, (-ABS)	2/95-	LUC	B	20,6	802552	802552	
1.4/1.6i 16V/1.8Si/1.8D,TD,TDi, (-ABS)	2/95-	LUC	B	19,0	802506	802506	
Alle/All, ABS	2/95-	LUC	B	22,2	802513	802513	

Fiesta I

1.0/1.1	6/76-7/83	BEN	B	15,8	802524	802524	
1.0/1.1/1.3	6/76-7/83	BEN	B	17,4	802523	802523	
XR2	10/81-7/83	BEN	B	19,0	802558	802558	

Fiesta II

1.0/1.1/1.3/1.4	8/83-4/89	BEN	B	17,4	802539	802539	
1.6 Diesel	2/84-4/89	BEN	B	15,0	802555	802555	
XR2	2/84-4/89	BEN	B	20,6	802556	802556	



F/B

∅

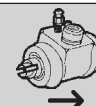
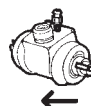

FORD

Fiesta III

1.1/1.3/1.4/1.8 D, (-ABS)	2/89-95	BEN	B	17,4	802549	802549	
1.1/1.3/1.4/1.6/1.8 D, ABS	2/89-95	BEN	B	22,2	802550	802550	
1.6 XR2i, (-ABS)	5/89-12/92	BEN	B	19,0	802557	802557	
1.6 XR2i, ABS	5/89-12/92	BEN	B	22,2	802550	802550	
1.8 16V XR2i, (-ABS)	1/92-12/94	BEN	B	19,0	802557	802557	
1.8 16V XR2i, ABS	1/92-12/94	BEN	B	22,2	802550	802550	
1.8i 16V, (-ABS)	1/92-12/94	BEN	B	19,0	802557	802557	
1.8i 16V, ABS	1/92-12/94	BEN	B	22,2	802550	802550	

Fiesta IV

Alle/All, Man.	8/95-	LUC	B	17,4	802507	802507	
Alle/All, Aut.	8/95-	LUC	B	22,2	802506	802506	

Fiesta V

Alle/All	11/01-		B	19,0	802567	802567	
----------	--------	--	---	------	---------------	---------------	--

Fiesta Courier

Alle/All	8/91-	LUC	B	22,2	802513	802513	
Alle/All, ABS	8/91-	BEN	B	22,2	802550	802550	

Focus

1.4i 16V/1.6 16V/1.8 16V Turnier, (-ABS)	10/98-	LUC	B	22,2	802513	802513	
1.4i 16V/1.6i 16V/1.8i 16V/1.8TDI, ABS	10/98-	LUC	B	20,6	802509	802509	
1.8 TD, (-ABS)	10/98-	LUC	B	19,0	802506	802506	
1.8 TD Turnier/ 2.0 16V, (-ABS)	10/98-	LUC	B	20,6	802552	802552	
1.8 TD Turnier, ABS	10/98-	LUC	B	20,6	802509	802509	

Granada

1.6	8/81-7/82	LUC	B	22,2	802513	802513	872561 U
1.7	2/75-7/77	LUC	B	20,6	802509	802509	872512 U
1.7 (S)	2/75-7/77	LUC	B	17,4	802507	802507	
1.7	8/77-7/81	LUC	B	19,0	802506	802506	
1.7 (DK,N,S,SF)	8/77-4/79	LUC	B	20,6	802509	802509	872512 U
1.7 Turnier	2/75-7/81	LUC	B	19,0	802506	802506	
1.7 Turnier	5/79-7/81	LUC	B	20,6	802509	802509	872512 U
1.7 Turnier (DK,N,S,SF)	8/77-4/79	LUC	B	20,6	802509	802509	872512 U
2.0	2/75-4/79	LUC	B	19,0	802506	802506	
2.0	5/79-7/81	LUC	B	20,6	802509	802509	872512 U
2.0	8/81-3/85	LUC	B	22,2	802513	802513	872561 U
2.0 (DK,N,S,SF)	8/77-4/79	LUC	B	20,6	802509	802509	872512 U
2.0 (DK)	5/79-11/79	LUC	B	19,0	802506	802506	
2.0 (S)	2/75-7/77	LUC	B	17,4	802507	802507	
2.0 (SF)	5/79-7/81	LUC	B	19,0	802506	802506	



F/B

Ø

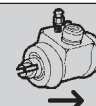
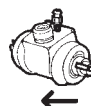

FORD

Granada

2.0 Turnier	2/75-7/81	LUC	B	19,0	802506	802506	
2.0 Turnier	8/81-3/85	LUC	B	22,2	802513	802513	872561 U
2.0 Turnier	8/79-7/81	LUC	B	20,6	802509	802509	872512 U
2.0 Turnier (DK,N,S,SF)	8/77-4/79	LUC	B	20,6	802509	802509	872512 U
2.1 Diesel	8/81-7/82	LUC	B	22,2	802513	802513	872561 U
2.1 Diesel	3/78-4/79	LUC	B	19,0	802506	802506	
2.1 Diesel (DK)	5/79-11/79	LUC	B	19,0	802506	802506	
2.1 Diesel (DK,N,S,SF)	3/78-4/79	LUC	B	20,6	802509	802509	872512 U
2.1 Diesel (SF)	5/79-7/81	LUC	B	19,0	802506	802506	
2.3	1/74-4/79	LUC	B	19,0	802506	802506	
2.3	5/79-7/81	LUC	B	20,6	802509	802509	872512 U
2.3	8/81-3/85	LUC	B	22,2	802513	802513	872561 U
2.3 (DK)	5/79-11/79	LUC	B	19,0	802506	802506	
2.3 (DK,N,S,SF)	8/77-4/79	LUC	B	20,6	802509	802509	872512 U
2.3 (S)	11/74-7/77	LUC	B	17,4	802507	802507	
2.3 (SF)	5/79-7/81	LUC	B	19,0	802506	802506	
2.3 Turnier	8/81-3/85	LUC	B	22,2	802513	802513	872561 U
2.3 Turnier	1/74-7/81	LUC	B	19,0	802506	802506	
2.3 Turnier	5/79-7/81	LUC	B	20,6	802509	802509	872512 U
2.3 Turnier (DK,N,S,SF)	8/77-4/79	LUC	B	20,6	802509	802509	872512 U
2.5 Diesel	8/82-3/85	LUC	B	22,2	802513	802513	872561 U
2.5 Diesel Turnier	8/82-3/85	LUC	B	22,2	802513	802513	872561 U
2.6	1/74-7/77	LUC	B	22,2	802513	802513	872561 U
2.6 (S)	11/74-7/77	LUC	B	17,4	802507	802507	
2.6 Turnier	1/74-7/77	LUC	B	22,2	802513	802513	872561 U
2.6 Turnier (S)	11/74-7/77	LUC	B	17,4	802507	802507	
2.8	5/79-7/81	LUC	B	20,6	802509	802509	872512 U
2.8	8/81-3/85	LUC	B	22,2	802513	802513	872561 U
2.8	1/77-4/79	LUC	B	19,0	802506	802506	
2.8 (DK)	5/79-11/79	LUC	B	19,0	802506	802506	
2.8 (DK,N,S,SF)	8/77-4/79	LUC	B	20,6	802509	802509	872512 U
2.8 (S)	1/77-7/77	LUC	B	17,4	802507	802507	
2.8 (SF)	5/79-7/81	LUC	B	19,0	802506	802506	
2.8 Turnier	8/77-7/81	LUC	B	19,0	802506	802506	
2.8 Turnier	8/81-3/85	LUC	B	22,2	802513	802513	872561 U
2.8 Turnier	5/79-7/81	LUC	B	20,6	802509	802509	872512 U
2.8 Turnier (DK,N,S,SF)	8/77-4/79	LUC	B	20,6	802509	802509	872512 U
3.0	1/74-7/77	LUC	B	19,0	802506	802506	
3.0 (S)	11/74-7/77	LUC	B	17,4	802507	802507	
3.0 Turnier	1/74-7/77	LUC	B	19,0	802506	802506	
3.0 Turnier (S)	11/74-7/77	LUC	B	17,4	802507	802507	



F/B

∅

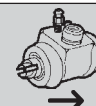
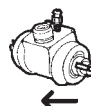

FORD

Ka

Alle/All	9/96-	LUC	B	17,4	802507	802507	
Alle/All	8/02-		B	19,0	802567	802567	

Maverick

Alle/All, (2 Dørs/Door/Türig)	2/93-8/96	O.E	B	22,2	802247	802247	
Alle/All, (4 Dørs/Door/Türig)	2/93-8/96	O.E	B	23,8	802248	802248	

Mondeo

1.6i/1.8i/1.8 TD	1/93-5/94	LUC	B	20,6	802561	802561	
1.6i/1.8i/1.8 TD	6/94-11/00	LUC	B	22,2	802566	802566	

1.6/1.8/2.0/1.8 TD Stationcar/Van	1/93-11/00	LUC	B	22,2	802562	802562	
-----------------------------------	------------	-----	---	------	---------------	---------------	--

2.0	1/93-11/00	LUC	B	20,6	802561	802561	
-----	------------	-----	---	------	---------------	---------------	--

Orion I

Alle/All	7/83-3/86	LUC	B	17,4	802507	802507	
----------	-----------	-----	---	------	---------------	---------------	--

Orion II

Alle/All	12/85-7/90	LUC	B	19,0	802506	802506	
Alle/All	12/85-7/90	LUC	B	22,2	802513	802513	872561 U

Orion III

Alle/All	7/90-12/93	LUC	B	20,6	802552	802552	
Alle/All (-ABS)	7/90-12/93	LUC	B	19,0	802506	802506	
Alle/All ABS	7/90-12/93	LUC	B	22,2	802513	802513	872561 U

Puma

1.4 16V & 1.7 16V	3/97-	LUC	B	19,0	802506	802506	
-------------------	-------	-----	---	------	---------------	---------------	--

Sierra

1.3/1.6	8/82-12/86	BEN	B	20,6	802536	802536	
1.6	1/87-	BEN	B	22,0	802551	802551	
1.6	1/87-	LUC	B	20,6	802509	802509	872512 U

1.6 Turnier	8/82-12/86	LUC	B	20,6	802509	802509	872512 U
-------------	------------	-----	---	------	---------------	---------------	-----------------

1.6 Turnier	1/87-	LUC	B	22,2	802513	802513	872561 U
-------------	-------	-----	---	------	---------------	---------------	-----------------

1.8	10/82-	LUC	B	20,6	802509	802509	872512 U
-----	--------	-----	---	------	---------------	---------------	-----------------

1.8 Turnier	8/85-12/86	LUC	B	20,6	802509	802509	872512 U
-------------	------------	-----	---	------	---------------	---------------	-----------------

1.8 Turnier	1/87-	LUC	B	22,2	802513	802513	872561 U
-------------	-------	-----	---	------	---------------	---------------	-----------------

2.0, (-ABS)	1/87-2/93	LUC	B	20,6	802552	802552	872512 U
-------------	-----------	-----	---	------	---------------	---------------	-----------------

2.0	8/82-	LUC	B	20,6	802509	802509	872512 U
-----	-------	-----	---	------	---------------	---------------	-----------------

2.0 i S	2/85-	LUC	B	20,6	802509	802509	872512 U
---------	-------	-----	---	------	---------------	---------------	-----------------

2.0 Turnier	10/85-12/86	LUC	B	20,6	802509	802509	872512 U
-------------	-------------	-----	---	------	---------------	---------------	-----------------

2.0 Turnier	1/87-	LUC	B	22,2	802513	802513	872561 U
-------------	-------	-----	---	------	---------------	---------------	-----------------



F/B

∅

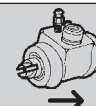
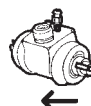

FORD

Sierra

2.0i S Turnier	8/85-12/86	LUC	B	20,6	802509	802509	872512 U
2.0i S Turnier	1/87-	LUC	B	22,2	802513	802513	872561 U
2.3	8/82-	LUC	B	20,6	802509	802509	872512 U
2.3 Diesel	8/82-	LUC	B	20,6	802509	802509	872512 U
2.3 Diesel Turnier	8/85-12/86	LUC	B	20,6	802509	802509	872512 U
2.3 Diesel Turnier	1/87-	LUC	B	22,2	802513	802513	872561 U
2.8 XR4i	1/83-1/85	LUC	B	22,2	802513	802513	872561 U
P 100 Pick up	88-	LCH	B	23,8	802544	802545	

Taurus

17M P3	62-64	ATE	B	17,4	802505	802505	
17M P3 Kombi	62-64	ATE	B	19,0	809914	809914	
17M/20M/Turnier	65-71	ATE	B	17,4	802505	802505	
20M RS/26M	68-71	ATE	B	17,4	802505	802505	
1.3/1.6	1/74-7/74	LUC	B	19,0	802506	802506	
1.3/1.6	8/74-7/82	BEN	B	19,0	802508	802508	
1.6 HD	1/74-12/75	LUC	B	17,4	802507	802507	
1.6 HD	1/76-7/82	LUC	B	19,0	802506	802506	
1.3 Turnier	1/74-7/74	LUC	B	19,0	802506	802506	
1.3 Turnier	8/74-7/82	BEN	B	19,0	802508	802508	
1.3 Turnier HD	1/74-12/75	LUC	B	17,4	802507	802507	
1.3 Turnier HD	1/76-7/82	LUC	B	19,0	802506	802506	
1.6 Turnier	1/74-7/74	LUC	B	19,0	802506	802506	
1.6 Turnier	8/74-7/82	BEN	B	19,0	802508	802508	
1.6 Turnier HD	1/74-12/75	LUC	B	17,4	802507	802507	
1.6 Turnier HD	1/76-7/82	LUC	B	19,0	802506	802506	
2.0/2.3	1/74-7/82	LUC	B	17,4	802507	802507	
2.0 Turnier	8/74-7/82	LUC	B	17,4	802507	802507	
2.3 Turnier	8/80-7/82	LUC	B	17,4	802507	802507	

Transit

100	76-4/80	LCH	B	20,3	802531	802531	879905 U
100	4/80-86	LCH	B	20,3	802531	802531	879905 U
100 Bus/Kombi/Van	86-91	LCH	B	20,3	802540	802540	
100 Van	86-91	LCH	B	22,2	802541	802542	



F/B

∅

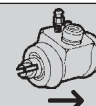
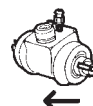

FORD

Transit

100L	76-4/80	LCH	B	20,3	802531	802531	879905 U
100L	4/80-86	LCH	B	20,3	802531	802531	879905 U
100L	86-87	LCH	B	22,2	802541	802542	
100L	88-91	LCH	B	20,3	802559	802560	
115 Bus/Kombi	7/76-	LCH	B	20,3	802531	802531	879905 U
120 Kombi	76-86	LCH	B	20,3	802531	802531	879905 U
120 Bus/Kombi/Van	86-91	LCH	B	20,3	802540	802540	
120 Chassis	86-91	LCH	B	22,2	802543	802543	
125 Kombi	5/72-4/78	LCH	F	22,2	809926	809927	
130 Bus/Kombi/Van	72-4/80	LCH	F	22,2	809926	809927	
130 Bus/Kombi/Van	4/80-86	LCH	F	22,2	809926	809927	
130 Kombi/Van	86-89	LCH	B	23,8	802544	802545	
130 Kombi/Van	5/89-	LCH	B	20,3	802559	802560	
150 Bus/Kombi/Van	5/72-86	LCH	F	22,2	809926	809927	
160	76-85	LCH	B	25,0	802532	802533	
160 Bus/Kombi/Van	86-91	LCH	B	25,4	802546	802547	
160 Kombi	86-91	LCH	B	23,8	802544	802545	
175 Bus/Kombi/Van	70-76	LCH	F	22,2	809926	809927	
175 Bus/Kombi/Van	76-86	LCH	F	22,2	809926	809927	
1750 Van 35 cwt.	65-9/68	LCH	F	22,0			
1750 Van 35 cwt.	9/68-12/70	LCH	B	19,0	802530	802530	
190	9/76-85	LCH	B	25,0	802532	802533	
190 Bus/Kombi/Van	86-91	LCH	B	25,4	802546	802547	
190 Benzin/Petrol & Diesel	9/91-	BEN	B	25,4	802565	802565	
80 Bus/Kombi/Van	86-91	LCH	B	20,3	802540	802540	
80-100L, S 115 & 120 E	9/91-	BEN	B	22,2	802563	802563	
80-120, 130, 150S & 150L	9/91-	BEN	B	20,6	802564	802564	
2.0 DI/2.4 DI	3/00-		B	25,4	802568	802568	
2.4 TDE	11/01-	BEN	B	25,4	802565	802565	



F/B

∅

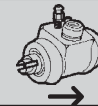
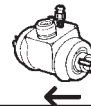

FORD USA

Maverick

2.4i & 2.7 TD, (2 Dørs/Door/Türig)	2/93-8/96	O.E	B	22,2	802247	802247
2.4i & 2.7 TD, (2 Dørs/Door/Türig)	9/96-4/98	O.E	B	23,8	802248	802248
2.4i & 2.7 TD, (4 Dørs/Door/Türig)	2/93-8/96	O.E	B	23,8	802248	802248

HANOMAG

Hanomag

F 25 CH. 6400229->	-1971	ATE	B	22,0	809906	809906
F 30 CH. 6600417->	-1971	ATE	B	22,0	809906	809906
F 35 CH. 6800096->	-1971	ATE	B	22,0	809906	809906
F 20 (CH, S)	1972	ATE	B	22,0	809906	809906
F 20/30/35	1972	ATE	B	22,0	809906	809906
F 20/25/30/35 L/DL (-S)	73-74	ATE	B	22,0	809906	809906
F 20/25/30/35 L/DL	73-74	ATE	F	22,0	809907	809907
L 406/DG/407 D/408 DG/508 DG	67-	ATE	B	22,0	803307	803307
L 406/DG/407 D/408 DG/508 DG	67-	ATE	F	22,0	803307	803307



F/B

∅

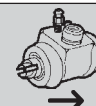
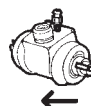

HONDA

Accord I (SJ,SY)

1.6	77-78	O.E	B	17,4	802601 U	802601 U
1.6	79-81	O.E	B	19,0	802605 U	802605 U
1.6	82-83	O.E	B	19,0	802608	802608

Accord II (AC,AD)

Alle/All	9/83-10/85	O.E	B	19,0	802608	802608
----------	------------	-----	---	------	---------------	---------------

Accord III (CA4,CA5)

Alle/All	11/85-12/89	O.E	B	20,6	802606	802606
----------	-------------	-----	---	------	---------------	---------------

Accord IV (CB_,CC_)

Alle/All	1/90-9/93	O.E	B	19,0	802617	802618
----------	-----------	-----	---	------	---------------	---------------

Accord VII (CG)

1.6	10/98-	O.E	B	20,6	802619	802620
-----	--------	-----	---	------	---------------	---------------

Civic I (S_)

1.2	72-76	O.E	B	17,4	802601 U	802601 U
1.2	76-80	O.E	B	15,9	802602	802602
1.3	80-81	O.E	B	17,4	809951 U	
1.3	82-9/83	O.E	B	19,0	802609	
1.5	75-80	O.E	B	17,4	802601 U	802601 U

Civic I (WC)

1.3 Wagon	82-9/83	O.E	B	17,4	809951 U	
-----------	---------	-----	---	------	-----------------	--

Civic II (A_)

Alle/All	10/83-10/87	O.E	B	19,0	802611	802612
----------	-------------	-----	---	------	---------------	---------------

Civic III (EC,ED,EE)

Alle/All	9/87-9/89	O.E	B	19,0	802611	802612
Alle/All	10/89-9/91	O.E	B	19,0	802613	802614

Civic IV (EG,EH,EJ,MA,MB)

Alle/All (-1.4)	10/91-1/97	O.E	B	19,0	802613	802614
1.4	10/91-1/97	O.E	B	19,0	803413	803414

Civic V (EJ9,EK1/3/4),(MB),(MC)

1.4/1.5	11/95-96	O.E	B	19,0	909953	909954
1.4/1.5	96-97	O.E	B	19,0	802613	802614
1.4/1.5	1/98-2/01	O.E	B	19,0	803413	803414
1.6	11/95-2/01	O.E	B	19,0	802613	802614

Civic VI (EU_,EP_)

1.6/1.7	2/01-	OE	B	19,0	802621	802622
2.0 Type-R	9/01-	OE	B	20,6	802623	802624

Civic I Shuttle (AN,AR)

1.5	10/83-10/87	O.E	B	19,0	802611	802612
-----	-------------	-----	---	------	---------------	---------------



F/B

∅

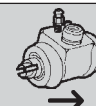
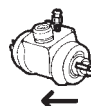

HONDA

Civic II Shuttle (EE)

1.4	1/88-12/92	O.E	B	19,0	802607	802607
1.5	1/88-11/91	O.E	B	19,0	802607	802607
1.6	1/88-6/89	O.E	B	19,0	802607	802607

Concerto (HW)

1.4/1.5/1.6	8/89-3/95	O.E	B	19,0	809953	809954
-------------	-----------	-----	---	------	---------------	---------------

CR-V I (RD1,RD3)

2.0 16V	1/99-	O.E	B	20,6	802623	802624
---------	-------	-----	---	------	---------------	---------------

CR-V II

2.0 16V	7/02-	O.E	B	20,6	802623	802624
---------	-------	-----	---	------	---------------	---------------

CRX I (AF,AS)

Alle/All	10/83-10/87	O.E	B	19,0	802611	802612
----------	-------------	-----	---	------	---------------	---------------

CRX III (EH)

1.6	3/92-12/98	O.E	B	19,0	802613	802614
-----	------------	-----	---	------	---------------	---------------

HR-V (GH)

Alle/All	3/99-	O.E	B	19,0	802613	802614
----------	-------	-----	---	------	---------------	---------------

Jazz (AA)

1.2	10/83-10/86	O.E	B	19,0	802609	
-----	-------------	-----	---	------	---------------	--

Prelude I (SN)

1.6	1/82-10/82	O.E	B	17,4	809951 U	
-----	------------	-----	---	------	-----------------	--

Prelude II (AB)

1.8	4/83-	O.E	B	19,0	802608	802608
-----	-------	-----	---	------	---------------	---------------

Quintet (SU)

1600, SU	80-83	O.E	B	17,4	809951 U	
----------	-------	-----	---	------	-----------------	--



F/B

∅

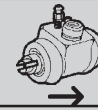
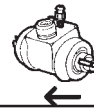

HYUNDAI

Accent (X-3)

Alle/All

10/94-1/00

O.E

B

19,0

803401

803402

Accent (LC)

Alle/All

1/00-

O.E

B

19,0

803413

803414

Atos

1.0

2/98-

B

17,5

803411

803412

Coupe

1.6/1.6i 16V, RD

12/96-4/02

O.E.

B

19,0

803405

803406

Getz (TB)

Alle/All

9/02-

B

17,5

803411

803412

H 100

2.5 Diesel, FDX

7/93-

O.E

B

20,6

803403

803404

Lantra I

Alle/All

10/90-11/95

O.E.

B

19,0

803405

803406

Lantra II

1.5/1.6/1.8

11/95-

O.E.

B

19,0

803405

803406

Pony

Alle/All

10/89-6/90

BEN

B

20,6

803409

803409

Alle/All

7/90-

MAN

B

20,6

803407

803408

S Coupe

Alle/All

2/90-6/92

BEN

B

20,6

803409

803409

Alle/All

7/92-5/96

MAN

B

20,6

803407

803408

Sonata

Alle/All

95-

O.E.

B

19,0

803405

803406



F/B

∅

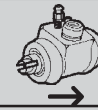
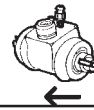

ISUZU

Campo(TFR/TFS)

Alle/All

1/83-12/90

O.E

B

25,4

801433

801433

KB/KBD

Alle/All

1/83-12/91

O.E

B

25,4

801433

801433

Trooper

2.0 G200Z/2.0 D C223

81-83

O.E

B

25,4

801433

801433

2.0 UBS 13

84-

O.E

B

22,2

801432

801432

2.2 D/2.3 TD UBS 52

83-

O.E

B

22,2

801432

801432

2.3 UBS 16

86-

O.E

B

22,2

801432

801432

2.6i, UBS 17

10/87-10/88

O.E

B

25,4

801433

801433

2.8 TD, UBS55

10/87-10/88

O.E

B

25,4

801433

801433

KIA

Pregio

Alle/All

10/97-

B

19,0

803503

803504

Rio I

1.3/1.6

8/00-

B

17,4

803506

803506

Sephia

Alle/All

9/93-

19,0

803501

803501

Sportage

Alle/All

4/94-6/97

B

20,6

803502

803502

Alle/All

6/97-

B

20,6

803505

803505



F/B

Ø

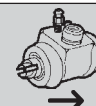
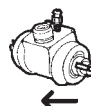

LADA

110/111/112

1.5&1.5 16V

1/95-

O.E

B

20,6

802306

802306

1200-1600

1200/1300/1500/1600

1/70-12/78

O.E

B

19,0

802304

802304

1200/1300/1500/1600

78-

O.E

B

20,6

802321

802321

1200/1300/1500/1600 (15)

78-

O.E

B

20,6

802306

802306

Niva

1600

12/76-3/95

O.E

B

20,6

802321

802321

Nova

1200/1300/1500

5/81-

O.E

B

20,6

802306

802306

Samara

1100/1300/1500

1/86-

O.E

B

20,6

802306

802306

LANCIA

A112

0.9/1.0

3/81-10/82

O.E

B

19,0

802304

802304

0.9/1.0

11/82-12/86

O.E

B

19,0

802328

802328

Dedra

Alle/All

8/89-7/99

O.E

B

19,0

802335

802335

Delta I

1.3/1.5 CH. ->229445

9/79-8/92

O.E

B

17,4

802320 U

802320 U

1.3/1.5/1.9 Turbo Diesel CH. 229446-262990

9/79-8/92

O.E

B

17,4

802331

802331

1.3/1.5/1.9 Turbo Diesel CH. 262991->

9/79-8/92

O.E

B

19,0

802328

802328

Delta II

Alle/All

6/93—8/99

BEN

B

22,2

802338

802338

Prisma

1.3/1.5 CH. ->3032272

1/83-

O.E

B

17,4

802331

802331

1.3/1.5 CH. 3032273->

-2/92

O.E

B

19,0

802328

802328

Diesel & Turbo Diesel

1/83-2/92

O.E

B

19,0

802328

802328

Y (840A)

1.1/1.2/1.2 16V

3/96-

BEN

B

20,6

802337

802337

1.1/1.2/1.2 16V

3/96-

LCH

B

20,6

802336

802336

1.4 12V

3/96-12/98

BEN

B

20,6

802337

802337

1.4 12V

3/96-12/98

LCH

B

20,6

802336

802336

Y10 (156)

Alle/All

3/85-12/95

O.E

B

19,0

802328

802328



LANCIA

Zeta

Alle/All



5/95-9/02



BEN

F/B

B



19,0

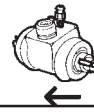

801926

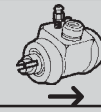

801926





F/B

∅

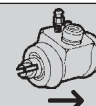
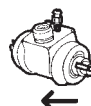

MAZDA

1000/1300

1.0 1/75-1/77 O.E B 19,0 803205 803205

1300

Alle/All 70-7/75 O.E B 19,0 803201 U 803201 U

Alle/All 7/75-8/76 O.E B 17,0 803202 U 803202 U

1600/1800

Alle/All 69-73 O.E B 17,0 803202 U 803202 U

121 (DA&DB)

Alle/All 10/87-3/96 O.E B 15,9 803230 803230

121 (JASM,JBSM)

Alle/All, Man. 3/96- O.E B 17,4 802507 802507

Alle/All, Aut. 3/96- O.E B 19,0 802506 802506

323 (FA)

Alle/All 1/77- O.E B 19,0 803205 803205

323 Wagon (FA)

Alle/All 5/78- O.E B 19,0 803217

323 (BD)

Alle/All 11/80- O.E B 17,4 803215 803215

323 (BF)

Alle/All 8/85- O.E B 17,4 803228 803228

323 Wagon (BW)

Alle/All 5/86- O.E B 17,4 803228 803228

323 (BG)

Alle/All 8/89- O.E B 17,4 803227 803227

323 F (BG)

Alle/All 8/89- O.E B 17,4 803227 803227

323 (BA)

Alle/All 7/94- O.E B 19,0 803229 803229

323 F (BA)

Alle/All 7/94- O.E B 19,0 803229 803229

323 (BJ)

Alle/All 9/98- O.E B 17,4 803227 803227

323 F (BJ)

Alle/All 9/98- O.E B 17,4 803227 803227



F/B

∅

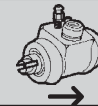
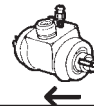

MAZDA

616

Alle/All

6/73-2/78

O.E

B

19,0

803201 U

803201 U

626 (CB)

Alle/All

5/79-12/80

O.E

B

20,6

803206 U

803207

626 (GC)

Alle/All

11/82-9/87

O.E

B

19,0

803221

803221

626 (GD)

Alle/All

6/87-8/91

O.E

B

17,4

803227

803227

626 (GE)

Alle/All

8/94-4/97

O.E

B

17,4

803227

803227

626 (GF)

Alle/All

5/97-12/99

O.E

B

17,4

803227

803227

626 (GV)

Alle/All

9/89-11/96

O.E

B

17,4

803227

803227

818

Alle/All

71-10/75

O.E

B

17,0

803202 U

803202 U

929

Alle/All

7/75-4/78

O.E

B

20,6

803206 U

803207

929 L

Alle/All

4/78-9/80

O.E

B

22,0

803209 U

B-Serie

1.8

10/81-84

O.E

B

22,2

803220 U

803220 U

2.2

1/85-10/90

O.E

B

19,0

803223 U

Demio

Alle/All

8/98-

O.E

B

17,4

803231

803231

E 2000/E 2200

Alle/All

1/84-

O.E

B

19,0

803223 U

Alle/All (9)

1/84-

O.E

B

17,4

803225

803226

MX3

Alle/All

7/91-

O.E

B

17,4

803227

803227



F/B

∅

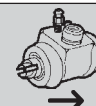
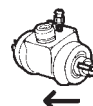

MERCEDES-BENZ

A-Klasse

Alle/All CH. ->J078973

7/97-

LUC

B

19,0

803316

803316

Alle/All CH. J078974->

7/97-

LUC

B

17,4

803315

803315

GD (W460)

Alle/All

3/79-7/93

ATE

B

17,5

803314

803314

GD (W461)

Alle/All

2/90-

ATE

B

17,5

803314

803314

GD (W463)

Alle/All

9/89-

ATE

B

17,5

803314

803314

MB 100 Series

Alle/All

2/88-2/96

LUC

B

25,4

803313

803313

T1 (601/602)

Alle/All

4/77-2/96

FAG

B

15,8

803312

803312

BM 605/606

L 206 DG/L 306 DG

10/72-77

ATE

F

22,0

809907

809907

L 206 DG/L 306 DG

ATE

B

22,0

809906

809906

L 207/L 307

10/72-77

ATE

B

22,0

809906

809906

L 207/L 307

ATE

F

22,0

809907

809907

BM 607/608

L 306/D 2700-3300 Kg.

ATE

B

22,0

809906

809906

L 206/D 2700-3300 Kg.

ATE

B

22,0

809906

809906

BM 611

407/409/410

1981-

ATE

F

22,0

809907

809907

MCC

Smart

Alle/All

7/98-10/99

B

17,4

803317

803318

Alle/All

11/99-

B

22,0

803319

803320



F/B

Ø

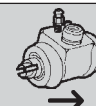
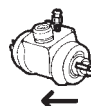

MITSUBISHI

Carisma

Alle/All	6/95-9/98	O.E	B	19,0	803019	803019
Alle/All	10/98-	O.E	B	19,5	803020	803020

Colt (C1_A)

Alle/All	12/78-4/88	O.E	B	19,0	803004	803004
----------	------------	-----	---	------	---------------	---------------

Colt (C5_A)

Alle/All	4/88-5/90	O.E	B	19,0	803004	803004
Alle/All	6/90-5/92	O.E	B	19,0	803017	803017

Colt (CA_A)

Alle/All	4/92-4/96	O.E	B	19,0	803017	803017
----------	-----------	-----	---	------	---------------	---------------

Colt (CJ_A)

Alle/All, (-ABS)	11/95-	O.E	B	19,0	803017	803017
Alle/All, ABS	11/95-	O.E	B	17,4	803018	803018

Cordia (A21_A)

Alle/All	10/82-12/86	O.E	B	17,4	803011	803011
----------	-------------	-----	---	------	---------------	---------------

Galant (E1A_)

1.6/1.8	6/84-12/87	O.E	B	17,4	803011	803011
---------	------------	-----	---	------	---------------	---------------

Galant (E3A_)

1.8	11/87-6/89	O.E	B	17,4	803011	803011
1.8	7/89-10/92	O.E	B	17,4	803018	803018

L200 (K_4T)

2.5 D/2.5 TD 4WD/2.6 4WD	12/87-8/96	O.E	B	22,2	803012	803013
2.5 D	11/86-8/96	O.E	B	23,8	803014	803015

L200 (K6_T)

Alle/All	6/96-	O.E	B	23,8	803014	803015
----------	-------	-----	---	------	---------------	---------------

L300

1.6 (P02V,P12V)	11/90-	O.E	B	22,2	803012	803013
Alle/All -1.6 (P02V,P12V)	9/81-	O.E	B	20,6	803002	803003

L400

Alle/All	6/96-	O.E	B	22,2	803012	803013
Alle/All	6/96-	O.E	B	23,8	803015	803015

Lancer

Alle/All	11/83-5/90	O.E	B	19,0	803004	803004
Alle/All	6/90-95	O.E	B	19,0	803017	803017

1.5/1.6 16V, (-ABS)

12/95-	O.E	B	19,0	803017	803017
--------	-----	---	------	---------------	---------------

1.5/1.6 16V, ABS

12/95-	O.E	B	17,4	803018	803018
--------	-----	---	------	---------------	---------------

1.6 16V 4WD

6/92-	O.E	B	17,4	803011	803011
-------	-----	---	------	---------------	---------------



F/B

∅

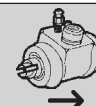
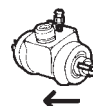

MITSUBISHI

Lancer Wagon

Alle/All -4x4

9/85-6/92

O.E

B

20,6

803016

803016

Pajero I

2.5 TD/3.0 V6

5/86-12/91

O.E

B

22,2

803012

803013

2.3 TD/2.6

12/82-11/90

O.E

B

20,6

803002

803003

Pajero II

2.4, 4 WD

4/91-4/00

O.E

B

23,8

803014

803015

Space Gear

Alle/All

5/95-

O.E

B

22,2

803012

803013

Space Runner

1800i 16V (N11W)

10/91-8/99

O.E

B

19,0

803017

803017

1800i 16V (N21W)/2.0 TD GLX (N18W)

10/91-8/99

O.E

B

19,0

803004

803004

Space Star

Alle/All

6/98-9/98

O.E

B

19,0

803019

803019

Alle/All

10/98-5/00

O.E

B

19,0

803004

803004

Alle/All

10/98-5/00

O.E

B

19,5

803020

803020

Space Wagon

Alle/All - 4X4 (D0_V/W)

1/84-4/91

O.E

B

20,6

803016

803016

1.8/1.8TD/2.0TD -4X4

10/91-10/98

O.E

B

19,0

803004

803004

Tredia

Alle/All

9/82-10/87

O.E

B

17,4

803011

803011



F/B

∅

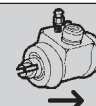
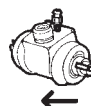

NISSAN

1000 B10

Alle/All

66-70

O.E

B

20,0

802209 U

802209 U

1200 B110

Alle/All

70-73

O.E

B

20,0

802209 U

802209 U

100 NX (B13)

1.6

3/90-10/94

TOK

B

15,8

802241

802241

Almera I (N15)

Alle/All

9/95-7/00

TOK

B

15,8

802241

802241

Bluebird (T12/T72)

Alle/All

12/85-6/87

O.E

B

20,6

802217

802217

872226 U

Alle/All

7/87-12/90

O.E

B

22,2

802238

802238

Bluebird (U11/WU11)

Alle/All

10/83-9/87

O.E

B

20,6

802217

802217

872226 U

Alle/All

10/87-5/90

O.E

B

22,2

802238

802238

Cherry (E10)

1.0

9/70-9/78

O.E

B

17,4

802201

802202

Cherry (N12)

Alle/All

5/82-12/86

O.E

B

17,4

802222

802222

Datsun 100A

Alle/All

12/74-8/80

O.E

B

17,4

802201

802202

Datsun (140/160/180)

Alle/All

1/73-6/83

O.E

B

20,6

802217

802217

872226 U

Datsun (120)

Alle/All

5/73-11/77

O.E

B

20,0

802211 U

802211 U

Laurel

Alle/All

7/81-12/89

O.E

B

22,2

802238

802238

Micra (K10)

Alle/All

12/82-7/92

O.E

B

15,9

802225

802225

Micra (K11)

Alle/All

8/92-2/03

O.E

B

17,4

802244

802244

Patrol (K160/W160)

Alle/All

11/79-8/88

O.E

B

22,2

802226

802226

Patrol (K260/W260)

Alle/All

5/86-9/89

O.E

B

22,2

802226

802226

Alle/All

10/89-11/95

O.E

B

25,4

802245

802245



F/B

Ø

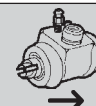
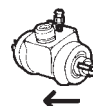

NISSAN

Patrol (Y60)

Alle/All

9/88-6/97

O.E

B

25,4

802245

802245

Patrol (Y61)

Alle/All -3.0DTi

6/97-

O.E

B

25,4

802245

802245

Pick up (720)

L18/SD23, 2 WD

7/80-11/81

O.E

B

17,0

802231

802231

Z22/SD25, 4 WD

12/81-3/83

O.E

B

14,3

802233 U

802233 U

1.8/2.2D/2.3D, 2 WD

1/82-3/86

O.E

B

17,4

802229

802229

2.2 & 2.5D 4WD, 4 WD

4/83-3/86

O.E

B

16,0

802232

802232

Pick up (D21)

2.0, 2 WD

9/85-8/91

O.E

B

17,4

802234

802234

2.5D 4WD, 4 WD

9/85-7/89

O.E

B

15,0

802236

802236

2.5D 4WD, 4 WD

8/89-

O.E

B

20,6

802246

802246

2.3D, 2 WD

9/85-8/88

O.E

B

19,0

802235

802235

Alle/All (4 cyl.)

9/85-2/98

O.E

B

22,2

802250

802250

Prairie (M10)

Alle/All

7/83-12/87

O.E

B

17,4

802224 U

802224 U

Prairie (NM10)

2.0 4X4

6/86-8/87

O.E

B

19,0

802237

802237

2.0 4X4

9/87-9/88

O.E

B

22,2

802238

802238

Prairie (M11)

2.0i

10/88-4/92

O.E

B

20,6

802217

802217

2.0i 4X4

10/88-12/92

O.E

B

22,2

802238

802238

2.4i 4X4

4/92-7/94

O.E

B

19,0

802237

802237

2.4i

4/92-7/94

O.E

B

17,4

802242

802242

Primera (P10)

1.6/2.0D

10/90-1/96

O.E

B

20,6

802239

802240

Primera Wagon (W10)

1.6/2.0D

7/90-3/98

O.E

B

20,6

802217

802217

872226 U

Primera (P11)

1.6 16V/2.0 TD

9/96-

O.E

B

802249

802249

Serena (C23M)

Alle/All

11/92-

O.E

B

23,8

802248

802248



F/B

∅

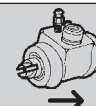
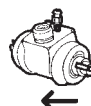

NISSAN

Silvia (S110)

1.8 Turbo

1/79-5/83

O.E

B

20,6

802217

802217

Silvia (S12)

2.0 GP

4/84-9/88

O.E

B

22,2

802238

802238

Stanza (T11)

Alle/All

8/81-12/85

O.E

B

17,4

802224 U

802224 U

Sunny (140Y,150Y)

Alle/All

1/70-2/82

O.E

B

20,6

802217

802217

Sunny (B11)

Alle/All

3/82-9/87

O.E

B

17,4

802222

802222

Sunny (N13,B12)

Alle/All

6/86-10/91

O.E

B

17,4

802222

802222

Sunny (N14)

1.4/1.6/2.0 D

10/90-5/95

TOK

B

15,8

802241

802241

Sunny Wagon (Y10)

Alle/All

11/90-

O.E

B

17,4

802242

802242

Terrano II (R20)

Alle/All, (3 Dørs/Door/Türig)

1/90-

O.E

B

22,2

802247

802247

Alle/All, (5 Dørs/Door/Türig)

1/90-

O.E

B

23,8

802248

802248

Urvan (E23)

2.0/2.3 Diesel

4/82-85

O.E

B

17,4

802229

802229

2.0/2.3 Diesel

85-87

O.E

B

19,0

802235

802235

Urvan (E24)

2.0/2.4 & 2.3 D/2.5 D

1/87-

O.E

B

20,6

802243

802243

Vanette (C22)

2.4i (SLC22)

10/86-12/95

O.E

B

20,6

802217

802217

Vanette Bus (C22)

Alle/All

10/86-12/95

O.E

B

17,4

802242

802242

Vanette Bus (KC120)

1.5

1/83-12/87

O.E

B

19,0

802237

802237

Vanette Kasse (C22)

2.0 D

7/91-1/95

O.E

B

19,0

802237

802237

Vanette Cargo

Alle/All

1/95-

O.E

B

23,8

802248

802248



F/B

Ø

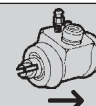
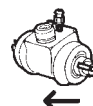

O

P E L			F/B	Ø			O
Arena							
Alle/All (-ABS)	3/98-8/01	BEN	B	23,8	803919	803919	
Alle/All (ABS)	3/98-8/01	LUC	B	25,4	803644	803644	
Ascona A							
1.6N CH. ->2453080,->9483907	10/70-	ATE	B	15,8	803606	803606	
1.6N CH. 2453081->, 9483908->	-9/74	ATE	B	15,8	803610	803610	
1.6S/1.9 CH. ->2761436, 9662824	70-	ATE	B	15,8	803606	803606	
1.6S/1.9 CH. 2761437->, 9662825->	-9/74	ATE	B	19,0	803611	803611	
Ascona B							
1.2/1.3N/1.6N	10/74-7/81	ATE	B	15,8	803610	803610	
1.3S/1.6N Aut./1.6S/1.9/2.0/2.0D	10/74-7/81	ATE	B	19,0	803611	803611	
1.2/1.3N/1.6N HD + (S)	10/74-7/81	ATE	B	19,0	809930	809930	
Ascona C							
1.3/1.6/1.8/2.0/Diesel	8/81-85	DEL	B	17,4	803623	803623	
CH. ->G6000000,->G1001771							
1.3/1.6/1.8/2.0/Diesel	86-8/88	ATE	B	17,4	803628	803628	
CH. G6000001->/G1001772->							
2.0i 95kW	10/87-8/88	ATE	B	19,0	803629	803629	
Astra F							
Alle/All CH. ->R2500000	10/91-	ATE	B	17,4	803628	803628	
Alle/All CH. R2500001->	10/91-	ATE	B	19,0	803629	803629	
Alle/All CH. R2500001-> (Aluminium) (18)	10/91-	ATE	B	19,0	803640	803640	
Astra F Caravan/Kombi							
Alle/All	10/91-	ATE	B	19,0	803629	803629	
Alle/All, (Aluminium) (18)	10/91-	ATE	B	19,0	803640	803640	
Astra G							
1.2/1.4 16V/1.6/1.7 TD Sedan & Caravan	2/98-	ATE	B	19,0	803629	803629	
1.2/1.6/1.7 TD Sedan & Caravan, (Aluminium) (18)	2/98-	ATE	B	19,0	803640	803640	
Campo							
Alle/All	8/91-8/96	O.E	B	25,4	801433	801433	
Combo (71_)							
Alle/All	7/94-10/01	DEL	B	19,0	803630	803630	
Combo (Kasse/Wagon)							
Alle/All, (Aluminium) (18)	10/01-	ATE	B	19,0	803640	803640	
Combo Tour							



F/B

∅

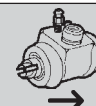
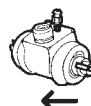

Alle/All, (Aluminium) (18)	10/01-	ATE	B	19,0	803640	803640
Commodore A						
Alle/All	8/67-1/72	ATE	B	17,4	803625	803625
OPEL						
Commodore B						
Alle/All	1/72-7/78	ATE	B	22,2	803616	803616
Commodore C						
Alle/All	8/78-12/82	ATE	B	22,2	803616	803616
Corsa A						
1.0 CH. ->G4000000	9/82-7/86	DEL	B	14,3	803622	803622
1.0 CH. G40000001->	8/86-	ATE	B	14,3	803627	803627
1.0/1.2/1.3 (+ HD) CH. ->G4000000	9/82-7/86	DEL	B	17,4	803623	803623
1.0/1.2/1.3 (+ HD) CH. G40000001->	8/86-93	ATE	B	17,4	803628	803628
1.4/1.5 D/1.5 TD/1.6/1.6GSI	9/87-93	ATE	B	17,4	803628	803628
Corsa B						
Alle/All	3/93-9/00	ATE	B	19,0	803629	803629
Alle/All, (Aluminium) (18)	3/93-9/00	ATE	B	19,0	803640	803640
Corsa C						
Alle/All	9/00-	ATE	B	19,0	803629	803629
Alle/All, (Aluminium) (18)	9/00-	ATE	B	19,0	803640	803640
Frontera A						
Alle/All CH. ->SV720102	3/92-10/98	O.E	B	25,4	801433	803919
Kadett A						
Alle/All	62-65	ATE	B	15,8	803603	803603
Kadett B						
1.0/1.1/1.2	65-73	ATE	F	23,8	803604 U	803605
1.0/1.1/1.2	65-73	ATE	B	15,8	803603	803603
1.5/1.7/1.9	67-71	ATE	B	15,8	803606	803606
Kadett C						
1.0/1.2	8/73-7/79	ATE	F	23,8	803604 U	803605
1.0/1.2	8/73-7/79	ATE	B	15,8	803603	803603
GT/E/1.6/1.9/2.0	9/75-7/79	ATE	B	19,0	809930	809930
Kadett D						
1.0/1.2/1.3N	8/79-7/84	DEL	B	14,3	803620	803620
1.0/1.2/1.3 Kombi CH. ->2518194	8/79-	DEL	B	19,0	803609 U	803609 U
1.0/1.2/1.3 Kombi CH. 2518195->	-7/84	ATE	B	19,0	803619	803619
1.2 HD/1.3 Aut.	8/79-7/84	ATE	B	19,0	803611	803611



F/B

Ø

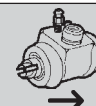
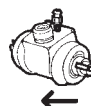

1.3N/S	8/79-7/84	DEL	B	17,4	803623	803623
1.6/1.8/1.6 D	82-7/84	DEL	B	17,4	803623	803623
OPEL						
Kadett D						
1.6/1.8/1.6 D Kombi	82-	DEL	B	17,4	803623	803623
CH. ->E2501707/ ->E5008740/->E6005529						
1.6/1.8/1.6 D Kombi	-7/84	ATE	B	17,4	803625	803625
CH. E2501708->/E5008741->/E6005530->						
Kadett E						
1.2/1.3 CH. ->G2502696/->G5000000	8/84-85	DEL	B	14,3	803620	803620
1.2/1.3 CH. G2502697->/ G5000001->	85-91	ATE	B	14,3	803627	803627
1.2/1.3/1.6/1.8/1.5 TD/1.6 D/1.7 D	8/84-85	DEL	B	17,4	803623	803623
CH. ->G2502696/->G5000000						
1.2/1.3/1.6/1.8/1.5 TD/1.6 D/1.7 D	85-91	ATE	B	17,4	803628	803628
CH. G2502697->/ G5000001->						
1.4	1/90-2/93	ATE	B	17,4	803628	803628
2.0 CH. ->KE215465/-> K2500077/->/ K5025260	9/86-8/91	ATE	B	19,0	803629	803629
2.0 CH. KE215466->/K2500078->/K5025261->	9/86-8/91	ATE	B	17,4	803628	803628
Kadett E Kombi						
Alle/All CH. ->G2502696/->G5000000	8/84-7/85	ATE	B	19,0	803619	803619
Alle/All CH. G2502697->/ G5000001->	8/85-9/91	ATE	B	19,0	803629	803629
Alle/All CH. ->G2502696/->G5000000	8/84-7/85	ATE	B	17,4	803625	803625
Alle/All CH. G2502697->/G5000001->	8/85-9/91	ATE	B	17,4	803631	803631
Alle/All	8/84-9/91	DEL	B	19,0	803630	803630
Manta A						
1.2/1.6 N CH. ->2761436	70-	ATE	B	15,8	803610	803610
1.2/1.6 N CH. 2761437->	-9/74	ATE	B	19,0	809930	809930
1.6 S/1.9 CH. ->2761436	70-	ATE	B	15,8	803606	803606
1.6 S/1.9 CH. 2761437->	-9/74	ATE	B	19,0	803611	803611
Manta B						
1.2/1.3/1.6N	9/75-86	ATE	B	19,0	809930	809930
1.6S	9/75-82	ATE	B	19,0	803611	803611
1.8	82-88	ATE	B	19,0	803611	803611
1.9	9/75-11/77	ATE	B	19,0	803611	803611
2.0	12/77-88	ATE	B	19,0	803611	803611
400	8/81-7/86	ATE	B	19,0	803611	803611
Movano						
Alle/All	7/98-	BEN	B	23,8	803641	803642



F/B

Ø

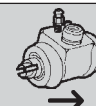
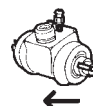

Olympia A

1.0 8/67-8/71 ATE B 15,8 **803603** **803603**
1.7/1.9 8/67-8/71 ATE B 15,8 **803606** **803606**

OPEL

Rekord B/C

Alle/All 65-71 ATE B 15,8 **803606** **803606**

Rekord D

1.7 72-77 ATE B 15,8 **803606** **803606**
1.7 (S) 72-77 ATE B 19,0 **803611** **803611**

1.9 72-77 ATE B 19,0 **803611** **803611**

2.0 75-77 ATE B 19,0 **803611** **803611**

2.1 Diesel 72-9/73 ATE B 15,8 **803606** **803606**
2.1 Diesel 10/73-77 ATE B 19,0 **803611** **803611**

Rekord E

1.7/1.9 77-9/82 ATE B 15,8 **803606** **803606**
1.7/1.9 HD CH. ->F1000188 9/77- ATE B 19,0 **803611** **803611**
1.7/1.9 CH. F1000189-> -86 DEL B 19,0 **803630** **803630**

1.8 CH. F1000189-> -86 DEL B 19,0 **803630** **803630**

1.8N 10/82-86 ATE B 15,8 **803606** **803606**
1.8N HD 10/82-86 ATE B 19,0 **803611** **803611**

2.0 CH. ->F1000188 9/77- ATE B 19,0 **803611** **803611**
2.0 CH. F1000189-> -86 DEL B 19,0 **803630** **803630**

2.0E (S) 9/77-8/86 ATE B 22,2 **803616** **803616**

2.2E CH. ->F1000128 9/85- DEL B 19,0 **803630** **803630**
2.2E CH. F1000129-> -8/86 ATE B 22,2 **803632 U** **803632 U**

Alle/All, ABS 84-86 ATE B 22,2 **803632 U** **803632 U**

Diesel CH. ->F1000188 77-9/82 ATE B 19,0 **803611** **803611**
Diesel CH. F1000189-> -86 DEL B 19,0 **803630** **803630**

Rekord E Kombi

Alle/All CH. ->F1000188 77- ATE B 22,2 **803616** **803616**
Alle/All CH. F1000189-> -86 ATE B 22,2 **803632 U** **803632 U**

Tigra

1.4 16V & 1.6 16V 7/94- ATE B 19,0 **803629** **803629**
1.4 16V & 1.6 16V, (Aluminium) (18) 7/94- ATE B 19,0 **803640** **803640**



F/B

∅

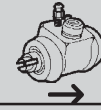
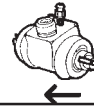

V

e
c
t
r
a

Zafira
Alle/All

4/99-

B

20,6

803643

803643



F/B

∅

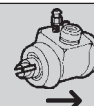
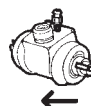

A

1.4/1.6/1.8/1.7 Diesel	9/88-8/95	ATE	B	19,0	803629	803629
1.4/1.6/1.8/1.7 Diesel, (Aluminium) (18)	9/88-8/95	ATE	B	19,0	803640	803640

OPEL

Vectra B

1.6	9/95-	ATE	B	19,0	803629	803629
1.6, (Aluminium) (18)	9/95-	ATE	B	19,0	803640	803640

PEUGEOT

104

GL	7/75-9/76	LUC	B	22,2	809932	809933
GL/GR/S/SR	9/76-	BEN	B	22,0	809911	809911
GL/GR/S/SR	9/76-	LUC	B	22,2	809935	809935

GL6/SL CH. 7236001-> CH. ->7241000 (5)		BEN	B	20,6	809910	809910
GL6/SL CH. 7236001-> CH. ->7241000		LUC	B	20,6	801918	801918

ZL	7/75-9/76	LUC	B	22,2	809932	809933
----	-----------	-----	---	------	--------	--------

ZA/ZL/ZS	9/76-	BEN	B	22,0	809911	809911
ZA/ZL/ZS	9/76-	LUC	B	22,2	809935	809935

106 I

Alle/All (165 mm. Tromle/Drum/Trommel), (-ABS)	9/91-4/96	BEN	B	19,0	803747	803748
Alle/All (180 mm. Tromle/Drum/Trommel), (-ABS)	9/91-4/96	BEN	B	19,0	809957	809958
Alle/All, ABS	9/91-4/96	BEN	B	19,0	803749	803749

106 II

1.0 (165 mm. Tromle/Drum/Trommel), (3 Bolthuller/Rim holes/Loch Felgen),	3/96-	BEN	B	19,0	803747	803748
1.0 (180 mm. Tromle/Drum/Trommel), (-ABS)	3/96-	BEN	B	19,0	809957	809958
1.0, ABS	3/96-	LUC	B	20,6	801930	801930

1.1/1.4/1.6, (-ABS)	3/96-	BEN	B	19,0	809957	809958
1.1/1.4/1.6, ABS	3/96-	LUC	B	20,6	801930	801930

1.5 Diesel, ABS CH. ->08056	3/96-	LUC	B	20,6	801930	801930
1.5 Diesel, ABS CH. 08057->	3/96-	LUC	B	20,6	803755	803755
1.5 Diesel (165 mm. Tromle/Drum/Trommel), (3 Bolthuller/Rim holes/Loch Felgen),	3/96-	BEN	B	19,0	803747	803748
1.5 Diesel (180 mm. Tromle/Drum/Trommel), (-ABS)	3/96-	BEN	B	19,0	809957	809958

205 I & II

Alle/All -GTI	2/83-9/98	BEN	B	19,0	803731	803732
Alle/All -GTI	2/83-9/98	LUC	B	19,0	803739	803740

Alle/All GTI & Rallye & Turbo Diesel	12/84-9/98	LUC	B	19,0	803739	803740
Alle/All GTI & Rallye & Turbo Diesel	12/84-9/98	LUC	B	19,0	803746	803746



F/B

Ø

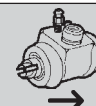
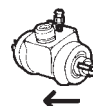

2

05							
a							
s							
s							
e							
1.7 Diesel	3/94-	BEN	B	19,0	803731	803732	
1.7 Diesel	3/94-	LUC	B	19,0	803739	803740	
206							
1.1/1.4/1.6/1.9 D/2.0 HDi	9/98-	LUC	B	20,6	803755	803755	
305 II							
Alle/All	10/82-7/90	BEN	B	20,6	809931	809931	
Alle/All	10/82-7/90	LUC	B	20,6	809940	809940	
PEUGEOT							
306							
1.1/1.4/1.6SR/1.8/1.7D/1.9D&TD	5/93-	BOS	B	20,6	801927	801927	
1.1/1.4/1.6SR/1.8/1.7D/1.9D&TD, (-ABS) (6)	5/93-	BEN	B	20,6	803929	803930	
1.1/1.4/1.6SR/1.8/1.7D/1.9D&TD, (-ABS) (6)	5/93-	LUC	B	20,6	809949	809950	
1.4/1.6SR/1.8/1.7D/1.9D&TD, ABS	5/93-7/95	LUC	B	20,6	809934	809934	
1.4/1.6SR/1.8/1.7D/1.9D&TD, ABS	5/95-	LUC	B	20,6	801930	801930	
1.6, (-ABS) (6)	10/00-	LUC	B	20,6	809949	809950	
1.6, ABS	10/00-	LUC	B	20,6	803755	803755	
306 Break							
Alle/All, (-ABS)	2/97-	BOS	B	20,6	801927	801927	
Alle/All, ABS	2/97-	BOS	B	22,0	801932	801932	
309 I							
1.1/1.3	10/85-7/89	BEN	B	17,4	809945	809946	
1.6/1.9	9/85-6/89	BEN	B	22,2	809942	809941	
1.6/1.9	10/85-12/89	LUC	B	22,2	809932	809933	
309 II							
Alle/All (-GTi)	7/89-12/93	BEN	B	20,6	803741	803742	
Alle/All (-GTi) (6)	7/89-12/93	LUC	B	20,6	809947	809948	
Alle/All, ABS	7/89-12/93	LUC	B	20,6	809934	809934	
405 I & II							
Alle/All (-ABS)	1/87-10/95	O.E	B	20,6	803743	803744	
Alle/All	1/87-10/95	LUC	B	20,6	803754	803754	
Alle/All	1/87-10/95	BEN	B	20,6	809940	809940	
405 I Break							



F/B

∅

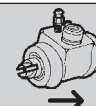
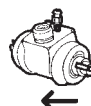

Alle/All (- ABS)	10/88-8/92	BEN	B	20,6	809940	809940
Alle/All (ABS)	10/88-8/92	LUC	B	20,6	803754	803754
405 II Break						
Alle/All (- ABS)	8/92-10/96	BEN	B	20,6	809940	809940
Alle/All (ABS)	8/92-10/96	LUC	B	20,6	803754	803754
406						
1.6/1.8/1.9 D & 1.9 TD Berline, (-ABS)	11/95-	BEN	B	20,6	803752	803753
1.6/1.8/1.9 D & 1.9 TD Berline, ABS	11/95-	BEN	B	20,6	803750	803751
1.8 & 1.9 TD Break, (-ABS)	10/96-	BEN	B	20,6	803752	803753
1.8 & 1.9 TD Break, ABS	10/96-	BEN	B	20,6	803750	803751
504						
Alle/All	7/68-12/89	LUC	B	22,2	809932	809933
Break/Cabriolet/Coupe/Pick						
Alle/All	4/71-12/89	LUC	B	22,2	803745	803745
PEUGEOT						
505						
Alle/All CH. 1214235->	8/79-12/93	BEN	B	20,6	809929	809929
Alle/All CH. ->1214234	8/79-12/93	LUC	B	22,2	809932	809933
Alle/All CH. 1214235->	8/79-12/93	LUC	B	20,6	809934	809934
505 Break						
Alle/All	4/82-12/93	LUC	B	22,2	803745	803745
806						



F/B

∅

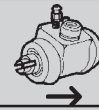
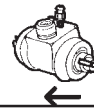

1.8/1.9 TD/2.0i

6/94-8/02

BEN

B

19,0

801926

801926

Boxer (230)

Alle/All 1000/1400 Kg.

Alle/All 1000/1400 Kg.

Alle/All 1800 Kg.

3/94-4/02

LUC

B

25,4

802340

802340

3/94-4/02

LUC

B

27,0

802341

802341

3/94-4/02

LUC

B

28,6

802342

802342



F/B

Ø

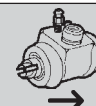
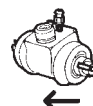

E

x p e r t							
Alle/All	2/96-	BEN	B	19,0	801926	801926	
J 5							
Alle/All	9/81-10/82	LUC	B	22,2	809944 U	809944 U	
Alle/All	11/82-	LUC	B	25,4	809936	809936	
Alle/All 1800 Kg.	9/87-	LUC	B	27,4	809955	809955	
Alle/All 800 Kg.	2/89-	LUC	B	22,2	801928	801928	
Partner							
Alle/All	6/96-	LUC	B	22,2	801929	801929	
PORSCHE							
924							
Alle/All	8/75-8/85		B	19,0	805601	805601	
RENAULT							
4							
0.8/1.1	10/62-6/90	BEN	F	23,8	803901	803902	
0.8 CH. ->21494	10/62-7/66	BEN	B	19,0	803903	803903	
0.8 CH. 21495->	10/62-6/90	BEN	B	21,0	803906	803906	
0.8/1.0/1.1	7/82-6/90	BEN	B	22,2	803904	803904	
0.8/1.0/1.1	7/82-6/90	LUC	B	22,2	803905	803905	
5							
0.8	10/72-12/84	BEN	F	23,8	803901	803902	
0.8 CH. ->116673	7/71-	BEN	B	19,0	803903	803903	
0.8/1.0/1.1/1.3/1.4	10/72-12/85	BEN	B	22,2	803904	803904	
0.8/1.0/1.1/1.3/1.4	10/72-12/85	LUC	B	22,2	803905	803905	
5 Super							
Alle/All	10/84-5/87	BEN	B	22,2	809942	809941	
Alle/All	6/87-10/90	BEN	B	20,6	803940	803941	
Alle/All	10/84-10/90	LUC	B	22,2	809932	809933	
6							
0.8	10/69-4/80	BEN	B	23,8	803901	803902	
1.1	8/70-4/87	BEN	B	22,2	803904	803904	
1.1	8/70-4/87	LUC	B	22,2	803905	803905	
9							
Alle/All	81-9/86	BEN	B	17,4	809945	809946	



F/B

∅

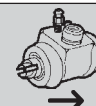
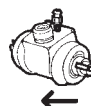

Alle/All	10/86-	BEN	B	22,2	809942	809941
Alle/All	81-	LUC	B	22,2	809932	809933
11						
Alle/All	83-9/86	BEN	B	17,4	809945	809946
Alle/All	10/86-	BEN	B	22,2	809942	809941
Alle/All	83-	LUC	B	22,2	809932	809933
12						
Berline CH. 296081->	10/69-8/80	LUC	B	22,2	803922	803922
Break	8/70-8/80	BEN	B	22,0	803911 U	803911 U
14						
Alle/All	5/76-12/83	BEN	B	22,2	809942	809941
Alle/All	5/76-12/83	LUC	B	22,2	809932	809933
15						
1.6	3/72-10/80	BEN	B	22,0	803911 U	803911 U
16						
Alle/All	9/65-8/80	BEN	B	22,0	803911 U	803911 U
17						
Alle/All	3/72-10/80	BEN	B	22,0	803911 U	803911 U
18 Berline						
L,TL,GTL R1340/1349	4/78-6/83	BEN	B	22,2	809941	809942
L,TL,GTL R1340	7/83-	BEN	B	22,2	809941	
L,TL,GTL R1340/1349	4/78-	LUC	B	22,2	809933	809932
TS,GTS R1341/1342	4/78-6/83	BEN	B	22,2	809941	809942
TS,GTS R1341/1342	7/83-	BEN	B	22,2	809941	
TS,GTS R1341/1342	4/78-	LUC	B	22,2	809933	809932
TX,GTX R1343	10/81-	BEN	B	22,0	809943	809943
TD,GTDR1344	10/80-	BEN	B	22,2	809941	809942
TD,GTDR1344	10/81-	LUC	B	22,2	809933	809932
Turbo R1345	10/80-7/82	BEN	B	22,0	809943	809943
Turbo Diesel R1346	7/83-	BEN	B	22,0	809943	809943
18 Break						
TL R1350 CH. ->114800	2/79-	BEN	B	22,0	809943	809943
TL R1350 CH. 114801->		BEN	B	22,0	809943	803917
GTL R1351 CH. ->107200	2/79-	BEN	B	22,0	809943	809943
GTL R1351 CH. 107201->		BEN	B	22,0	809943	803917
GTL 4x4 R1351	83-	BEN	B	22,0	809943	803917

RENAULT



F/B

∅

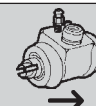
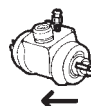

GTS R1352 CH. ->5480	10/81-	BEN	B	22,0	809943	809943
GTS R1352 CH. 5481->		BEN	B	22,0	809943	803917
TS,GTS R1352 CH. ->5400	10/81-	BEN	B	22,0	809943	809943
TS,GTS R1352 CH. 5401->		BEN	B	22,0	809943	803917
GTX R1353 CH. ->5000	10/81-	BEN	B	22,0	809943	809943
GTX R1353 CH. 5001->		BEN	B	22,0	809943	803917
GTX 4x4 R1353	83-	BEN	B	22,0	809943	803917
GTD R1354	10/80-	BEN	B	22,0	809943	809943
GTD 4x4 R1354	83-	BEN	B	22,0	809943	809943
TL R1359 (S,CH) CH. ->200	2/79-	BEN	B	22,0	809943	809943
TL R1359 (S,CH) CH. 201->		BEN	B	22,0	809943	803917
Société R2350 CH. ->3400	10/81-	BEN	B	22,0	809943	809943
Société R2350 CH. 3401->		BEN	B	22,0	809943	803917
Société Diesel R2354	10/81-	BEN	B	22,0	809943	809943
Turbo R135B	10/83-	BEN	B	22,0	809943	809943
RENAULT						
18 Break						
Turbo Diesel R1356	10/83-	BEN	B	22,0	809943	809943
19 I						
Alle/All	9/88-3/91	BEN	B	20,6	803927	803928
Alle/All (6)	4/91-	BEN	B	20,6	803929	803930
Alle/All	4/91-	LUC	B	20,6	803948	803949
19 II						
Alle/All	4/92-6/96	BEN	B	19,0	803955	803956
Alle/All (6)	4/92-6/96	BEN	B	20,6	803929	803930
Alle/All	4/92-6/96	LUC	B	20,6	803948	803949
20						
Alle/All	10/75-12/83	BEN	B	22,0	803933	803934
Alle/All	10/75-12/83	LUC	B	23,8	803935	803935 U
21						
Alle/All	7/86-5/87	BEN	B	22,2	809942	809941
Alle/All	6/87-3/91	BEN	B	22,0	803944	803944 U
Alle/All	4/91-	BEN	B	22,0	803946	803947
25						
Alle/All, (-ABS)	4/84-12/93	BEN	B	22,0	803933	803934
Alle/All, (-ABS)	4/84-12/93	LUC	B	23,8	803935	803935 U



F/B

Ø

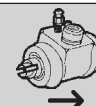
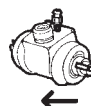

3

			F/B	Ø		
0						
2.1 Turbo Diesel	2/82-3/86	BEN	B	22,0	803933	803934
2.1 Turbo Diesel	2/82-3/86	LUC	B	23,8	803935	803935 U
Clio I						
Alle/All (- 1.7 16S)	6/90-3/91	BEN	B	20,6	803940	803941
Alle/All (- 1.7 16S)	4/91-9/98	BEN	B	20,6	803925	803926
Alle/All	6/90-3/91	LUC	B	20,6	803951	803952
Alle/All	4/91-9/98	LUC	B	20,6	803953	803954
Clio II						
1.2/1.4/1.5 Dci/1.6/1.9 D/1.9 Dti, (-ABS)	9/98-	BOS	B	19,0	803967	803967
1.2/1.4/1.5 Dci/1.6/1.9 D/1.9 Dti, ABS	9/98-	BOS	B	17,5	803966	803966
1.2/1.4/1.5 Dci/1.6/1.9 D/1.9 Dti, ABS	9/98-	LUC	B	17,8	803960	803960
Espace I						
Alle/All	7/84-12/92	BEN	B	22,0	809943	809943
Espace II						
Alle/All -2.1 TD	1/91-4/92	BEN	B	22,0	809943	809943
2.1 TD	11/94-10/96	LUC	B	22,2	803745	803745
Espace III						
1.9 dti/2.0/2.2 12V	11/96-	LUC	B	22,2	803745	803745
Express (Rapid)						
GTC F 40H CH. ->E00000235	6/87-9/91	LUC	B	22,2	809932	809933
GTC F 40H CH. ->F00001604	6/87-9/91	LUC	B	22,2	809932	809933
GTC F 40H	6/87-9/91	BEN	B	22,2	809942	809941
C,TC F400 CH. ->J0002617	10/85-4/95	LUC	B	22,2	809932	809933
C,TC F400	10/85-4/95	BEN	B	22,2	809942	809941
TL F 401 CH. ->J00073241	10/85-4/95	LUC	B	22,2	809932	809933
TL F 401 CH. ->E00008743	10/85-4/95	LUC	B	22,2	809932	809933
TL F 401	10/85-4/95	BEN	B	22,2	809942	809941
Diesel F 404	10/85-6/86	LUC	B	22,2	809932	809933
1.4 Diesel & 1.6 Diesel	86-12/88	BEN	B	22,0		
1.4 Diesel & 1.6 Diesel	1/89-8/98	BEN	B	20,6	803931	803932
Fuego						
TL R1360 CH. ->59000	2/80-10/85	BEN	B	22,2	809941	809942
TL R1360 CH. 59001->	2/80-84	BEN	B	22,2	809941	
GTL R1361 CH. ->6100	82-10/85	BEN	B	22,2	809941	809942
TS,GTS R1362 CH. ->59300	2/80-10/85	BEN	B	22,0	809943	809943

RENAULT



F/B

Ø

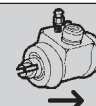
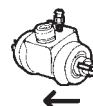

TS,GTS R1362 CH. 59301->	2/80-10/85	BEN	B	22,0	809943	803917
TX,GTX R1363	10/80-10/85	BEN	B	22,0	809943	809943
Turbo Diesel R1366	7/83-10/85	BEN	B	22,0	809943	809943
GTX Turbo Injection R136B	84-10/85	BEN	B	22,0	809943	809943
Kangoo						
Alle/All (16)	3/98-	O.E	B		803963	803963
Alle/All	3/98-	O.E	B		803964	803964
Laguna						
1.6 16V (B568, B561)	11/97-3/01	LUC	B	20,6	801930	801930
1.8, B56A/B	1/94-	LUC	B	19,0	803959	803959
1.9 dti (B56J)	10/97-3/01	LUC	B	20,6	801930	801930
2.0	3/99-3/01	LUC	B	20,6	801930	801930
2.0 B56C/H	1/94-	LUC	B	19,0	803959	803959
2.2 B56F	7/94-	LUC	B	19,0	803959	803959
1.8/2.2 & 2.2 D Grandtour	9/95-3/01	LUC	B	20,6	801930	801930
1.8/2.2 & 2.2 D Grandtour	9/95-3/01	LUC	B	22,2	803968	803968
RENAULT						
Nevada						
Alle/All	7/86-6/95	LUC	B	22,0	803961	803962
Master I						
Alle/All	8/80-7/98	LUC	B	25,4	809936	809936
Master II						
Alle/All	7/98-	BOS	B	23,8	803641	803642



F/B

Ø

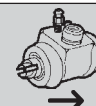
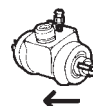

M

e
g
a
n
e

Alle/All	11/95-	BEN	B	17,4	803950	803950	
1.4 16V/1.6 16V, ABS	1/99-	O.E	B	19,0	803965	803965	
Megane Grandtour							
1.9 Diesel	4/99-	LUC	B	20,6	801930	801930	
Megane Scenic							
Alle/All	10/96-	LUC	B	20,6	801930	801930	
Safrane I							
2.0 & 2.2 & 2.1 TD, (-ABS)	5/92-7/96	LUC	B	22,2	803745	803745	
Scenic							
Alle/All	9/99-	LUC	B	20,6	801930	801930	
Trafic							
Alle/All	3/80-	BEN	B	23,8	803919	803919	
Alle/All	3/80-	LUC	B	22,0	803917	803917	
Alle/All (ABS)	3/80-	LUC	B	25,4	803644	803644	
Twingo							
Alle/All, (-ABS)	3/93-	BEN	B	20,6	803957	803958	
Alle/All, ABS	3/94-	BEN	B		801931	801931	
1.2 16V (C06_), ABS	1/01-	LUC	B	17,8	803960	803960	
ROVER GROUP							
Austin							
1300	67-74	LCH	B	20,3	801205	801205	879905 U
2200	10/72-75	LUC	B	18,0	801220 U	801220 U	
2200 (3)	10/72-75	LUC	B		899901	899901	
Austin Allegro							
Alle/All	73-84	LUC	B	14,3	801214	801214	
Alle/All (3)	73-84	LUC	B		899901	899901	
Austin Maestro							
Alle/All	83-95	LUC	B	15,8	801226	801227	
Austin Maxi							
Alle/All	69-10/78	LUC	B	17,4	809919	809919	
Alle/All	11/78-81	LUC	B	14,3	801207	801207	
Austin Metro							



F/B

Ø

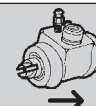
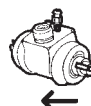

Alle/All	10/80-4/90	LCH	B	17,4	801225	801225	
Austin Mini MK I							
850/1000 & Clubman	59-	LCH	B		891202	891202	
850/1000	59-64	LCH	B	19,0	809916	809916	
1000/1300/1300 Cabriolet	91-	LCH	B	19,0	809916	809916	
850/1000 & Clubman	67-84	LCH	F	24,0	801201	801202	
850/1000 & Clubman	67-77	LCH	B	19,0	809916	809916	
850/1000 & Clubman	8/78-	LCH	B	19,0	809916	809916	
1275 GT (10" Hjul/Wheels/Rad)	69-74	LCH	B	16,0	809917	809917	
1275 GT (12" Hjul/Wheels/Rad)	9/78-80	LCH	B	19,0	809916	809916	
850/1000	64-67	LCH	B	16,0	809917	809917	
850/1000 & Clubman Comm. CH. 21571A->	-7/78	LCH	B	14,0	801204	801204	
Mini Cooper (MK III)							
Alle/All) (14)	69-71	LCH	B	16,0	809917	809917	
Austin MK I							
1100	63-67	LCH	B	19,0	809916	809916	
Austin MK I / II & III							
1800	5/65-75	LUC	B	18,0	801220 U	801220 U	
1800 (3)	5/65-75	LUC	B		899901	899901	
Austin MK II & III							
1100	67-74	LCH	B	20,3	801205	801205	879905 U
Austin Montego							
Alle/All	4/84-8/91	LUC	B	17,4	801228	801229	
ROVER GROUP							
Austin Princess							
Alle/All	4/76-10/82	LCH	B	14,3	801222 U	801222 U	
Morris Marina							
Marina 1.3 CH. ->172478	4/71-72	LUC	F	19,0	809922	809923	
Marina 1.3	4/71-80	LUC	B	17,4	809919	809919	
Marina 1.3 CH. 172479->	72-80	LUC	B	19,0	809915	809915	
Marina 1.8 CH. 172479->	-8/82	LUC	B	17,4	809919	809919	
Morris Minor							
1000	56-71	LCH	F	24,0	801215	801216	
1000	62-71	LCH	B	19,0	801217	801217	
Land Rover Freelander							
1.8 16V/2.0 Di	2/98-	LUC	B	20,6	802552	802552	
Rover 100							
Alle/All	3/90-	LCH	B	17,4	801225	801225	



F/B

Ø

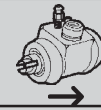
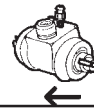

o
v
e
r

0
0

R

2

213

9/85-9/89

LCH

B

19,0

804001

804002

214/216/218 & 220

10/89-10/95

LCH

B

19,0

809953

809954

216

3/85-10/89

LCH

B

17,4

809951 U

Rover 400 (XW)

Alle/All

4/90-4/95

LCH

B

19,0

809953

809954

Rover Maestro

Alle/All

9/90-1/95

LCH

B

17,4

801225

801225



F/B

∅

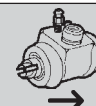
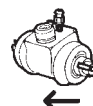

Rover Mini MK I

Alle/All

1/91-

LCH

B

19,0

809916

809916

Acclaim

1.3

1/82-12/85

LCH

B

19,0

804001

804002

Herald

Alle/All

1/61-12/71

LUC

F

19,0

809915

809923

Alle/All

1/61-12/71

LUC

B

19,0

809915

809915

Spitfire II & III

Alle/All

12/65-12/70

LUC

B

19,0

809915

809915

MG RV8

Alle/All

93-

LCH

B

20,3

802531

802531

879905 U

MGB GT

Alle/All

62-67

LCH

B

20,3

801205

801205

879905 U

Alle/All

67-82

LCH

B

ROVER

GROUP

MGB Tourer & Roadster

Alle/All

62-82

LCH

B

20,3

801205

801205

879905 U

Sherpa

Alle/All (- 185)

74-

LCH

B

22,2

809926

809927

SAAB

95/96

Alle/All

62-80

LCH

B

16,0

809917

809917

Alle/All

62-80

LCH

B

19,0

809916

809916

SEAT

Arosa

Alle/All, (-ABS)

5/97-

O.E

B

15,8

804709

804709

Alle/All, ABS (18)

5/97-

O.E

B

17,4

804739

804739

Cordoba



F/B

∅

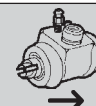
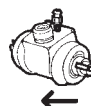

1.4/1.6/1.8/1.9 D/1.9 TD (18)	11/93-	ATE	B	17,4	804739	804739
Cordoba (6K1/C2)						
1.7 Sdi & 1.9 Sdi	8/96-6/99	O.E	B	17,4	804706	804706
1.4 16V/1.6	6/99-10/02	LUC	B	19,0	804735	804735
Fura						
Alle/All	1/82-12/86	BEN	B	19,0	802304	802304
Ibiza I						
Alle/All	6/84-12/93	O.E	B	17,4	802331	802331
Ibiza II						
Alle/All	3/93-8/99	O.E	B	17,4	804706	804706
Ibiza III (6K1)						
1.0/1.4, (-ABS) (18)	8/99-2/02	O.E	B	17,4	804739	804739
1.4i 16V (44-55-74 kW)/1.6i (55kW),	8/99-2/02	ATE	B	17,4	804706	804706
1.4i 16V (44-55-74 kW)/1.6i (55kW),(-ABS) (17)	8/99-2/02	LUC	B	19,0	804735	804735
1.9 Sdi & Tdi, (Aluminium), (-ABS) (17+18)	8/99-2/02		B	19,0	804306	804306
1.9 Sdi & Tdi, (-ABS) (18)	8/99-2/02	ATE	B	17,4	804739	804739
Ibiza IV (6L1)						
Alle/All (- Cupra), (-ABS) (17)	2/02-	LUC	B	19,0	804735	804735
Inca						
1.4/1.6 & 1.9 D, (Aluminium) (18)	11/95-	FAG	B	20,6	804738	804738
Malaga						
Alle/All	5/85-12/93	O.E	B	17,4	802331	802331
Marbella						
Alle/All	8/86-10/98	O.E	B	19,0	802328	802328
Ronda						
Alle/All	7/82-	O.E	B	17,4	802331	802331
Toledo I						
1.6/1.8/1.9 D/1.9 TD	5/91-	O.E	B	17,4	804706	804706
SKODA						
105/120/130						
Alle/All	8/76-10/91	O.E	B	19,0	804301	804301
Fabia						
1.0/1.4/1.9Sdi, (Aluminium) (18)	12/99-		B	19,0	804306	804306
Favorit						
Alle/All	89-12/92	O.E	B	19,0	804302	804302
Alle/All	1/93-	O.E	B	19,0	804303	804303
Felicia I-II (6U_)						



F/B

Ø

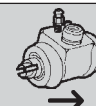
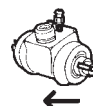

1.3/1.6/1.9D, (-ABS)	10/94-6/01	LUC	B	22,2	804304	804304
1.3/1.6/1.9D, (-ABS)	10/94-6/01	LUC	B	20,6	804305	804305
1.3/1.6/1.9D, ABS	10/94-6/01	OE	B	19,0	804303	804303
Felicia Fun (797)						
1.3/1.6/1.9D, (-ABS)	6/97-	LUC	B	22,2	804304	804304
1.3/1.6/1.9D, (-ABS)	6/97-	LUC	B	20,6	804305	804305
1.3/1.6/1.9D, ABS	6/97-	OE	B	19,0	804303	804303
Octavia						
Alle/All	9/96-		B	20,6	804736	804736
Alle/All, Aut.	9/96-	LUC	B	19,0	804735	804735
Alle/All, (Aluminium) (18)	9/96-	FAG	B	20,6	804738	804738
Rapid						
Alle/All	2/83-10/91	O.E	B	19,0	804302	804302
SUBARU						
Justy II						
1.3 4WD, (Aluminium) (18)	10/95-	O.E	B	17,4	805203	805204
Leone I						
Alle/All	3/79-10/84	O.E	B	14,3	804401	804401
SUZUKI						
Alto III (EF)						
1.0	9/94-6/02		B	17,4	805205	805205
Alto IV (FF)						
1.1	6/02-		B	15,8	805206	805206
Ignis (FH)						
1.3	10/00-9/03		B	15,8	805206	805206
Baleno (EG)						
Alle/All, (18)	7/95-		B	17,4	805203	805204
SUZUKI						
Swift I (AA)						
Alle/All, (18)	10/83-3/89		B	17,4	805201	805201
Swift II						
1.0/1.3, Hatchback (3&5 Dørs/Door/Türig)	3/89-		B	15,8	805202	805202
1.3, Hatchback (3&5 Dørs/Door/Türig) (18)	3/89-		B	17,4	805201	805201
1.3/1.6, Sedan (4 Dørs/Door/Türig) (18)	3/89-		B	17,4	805203	805204
Wagon R+ (EM)						
1.0/1.2	2/98-5/00		B	15,8	805206	805206



F/B

Ø

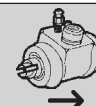
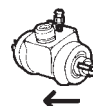

Wagon R+ (MM)

1.3 5/00- B 15,8 805206 805206

Vitara

Alle/All 12/94-3/99 B 22,2 805207 805208

X-90

Alle/All 9/95- B 22,2 805207 805208

TALBOT

1307-1510

Alle/All 7/75-4/84 ATE B 20,6 801813 U 801813 U
 Alle/All 7/75-4/84 BEN B 20,6 809931 809931
 Alle/All 7/75-4/84 LUC B 20,6 809940 809940
 Alle/All 7/75-4/84 BEN B 22,0 809943 809943

Avenger

Alle/All 2/70-7/81 LUC B 18,0 801820 U 801820 U

Horizon

Alle/All 2/78-6/86 ATE B 20,6 801813 U 801813 U
 Alle/All 2/78-6/86 BEN B 20,6 809931 809931
 Alle/All 2/78-6/86 LUC B 20,6 809940 809940

Rancho

1.4 1/77-7/84 LUC B 20,6 809940 809940

Samba

Alle/All 1/81-10/86 BEN B 22,0 809911 809911
 Alle/All 1/81-10/86 LUC B 22,2 809935 809935

Simca Sunbeam

Alle/All 70-80 LUC B 18,0 801820 U 801820 U

Solara

Alle/All 2/80-7/86 ATE B 20,6 801813 U 801813 U
 Alle/All 2/80-7/86 BEN B 22,0 809943 809943

TALBOT

Tagora

2.6/2.3 Diesel 10/80-7/83 LUC B 20,6 809934 809934

Alle/All 6/80-12/87 BEN B 20,6 809929 809929

TOYOTA

Avensis

Alle/All 9/97-10/00 O.E B 20,6 804554 804553

Camry



F/B

∅

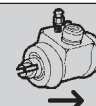
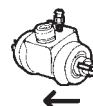

1.8 & 2.0	2/83-5/91	O.E	B	19,0	804529	804530	
Carina							
Alle/All	5/73-84	O.E	B	19,0	809938	809938	
Carina II							
AT151/ST150/CT150	6/84-1/86	O.E	B	19,0	804529	804530	
AT151/ST150/CT150	1/86-87	O.E	B	17,4	804532	804531	874552 U
AT171/CT170/ST171	12/87-93	O.E	B	19,0	804529	804530	
Carina E							
Alle/All (-UK)	4/92-9/97	Hos	B	19,0	804545	804546	
Alle/All (UK)	3/93-1/96	LUC	B	19,0	804549	804550	
Alle/All (UK)	1/96-9/97	LUC	B	20,6	804551	804552	
Celica (TA60,RA40,RA6_)							
Alle/All	8/77-8/85	O.E	B	19,0	809938	809938	
Celica (_T16_)&(_T18_)							
Alle/All	8/85-8/90	O.E	B	19,0	804529	804530	
Celica (AT180)							
Alle/All	3/90-	O.E	B	19,0	804547	804548	
Corolla (AL20)							
1300 TE	84-2/85	O.E	B	17,4	804532	804531	874552 U
Corolla (KE20)							
Alle/All	4/70-5/78	O.E	B	20,6	804507	804507	
Corolla (KE30)							
Alle/All	8/74-2/80	O.E	B	19,0	809938	809938	
Corolla (TE51)							
Alle/All	76-79	O.E	B	19,0	809938	809938	
Corolla (KE70 Van & KE76)							
Alle/All	2/80-	O.E	B	20,6	809939	809939	
							TOYOTA
Corolla (CE70)							
Alle/All	2/82-	O.E	B	19,0	809938	809938	
Corolla (TE71)							
Alle/All	8/79-	O.E	B	20,6	804507	804507	
Corolla (AE80/AE82)							
Alle/All	5/83-5/85	O.E	B	19,0	804529	804530	
Alle/All	6/85-87	O.E	B	17,4	804532	804531	874552 U
Corolla (CE80/EE80)							



F/B

∅

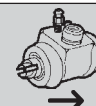
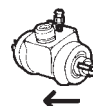

Alle/All	8/83-5/85	O.E	B	19,0	804529	804530	
Alle/All	6/85-87	O.E	B	17,4	804532	804531	874552 U
Corolla (EE90/AE92/CE90)							
Alle/All	5/87-4/92	O.E	B	17,4	804532	804531	
Corolla (EE90/AE92/CE90) Wagon							
Alle/All	5/87-4/92	O.E	B	19,0	804529	804530	
Corolla (AE95)							
1.6 Xli 4x4, 4 WD	8/88-6/92	O.E	B	19,0	804522	804522	
Corolla (_E10_)							
Alle/All	5/92-4/97	O.E	B	17,4	804532	804531	
Alle/All	5/92-4/97	O.E	B	19,0	804545	804546	
Alle/All	4/97-	O.E	B	19,0	804545	804546	874552 U
Corona							
1.8	6/79-7/81	O.E	B	20,6	804533	804533	
Cressida							
Alle/All	7/77-3/85	O.E	B	20,6	804533	804533	
Dyna 100							
LH80 CH. ->105260	8/85-	O.E	B	20,0	804534	804534	
LH80 CH. 105261->		O.E	B	23,8	804536	804536	
YH81 CH. ->102340	8/85-	O.E	B	20,0	804534	804534	
YH81 CH. 102341->		O.E	B	23,8	804536	804536	
Hiace I							
Alle/All	2/77-12/84	O.E	B	20,0	804534	804534	
Hiace II							
Alle/All	3/83-8/85	O.E	B	20,0	804534	804534	
Alle/All	5/85-11/89	O.E	B	23,8	804536	804536	
Hiace III							
Alle/All	8/89-8/95	O.E	B	23,8	804536	804536	
TOYOTA							
Hiace IV							
Alle/All	8/95-	O.E	B	23,8	804558	804558	
Hilux (2WD)							
Alle/All	1/84-	O.E	B	22,2	804541	804541	
Hilux (4WD)							



F/B

∅

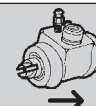
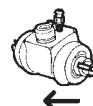

2.2, 4 WD	1/87-12/89	O.E	B	19,0	804542	804542	
2.4i & 2.4D, 4 WD	8/88-	O.E	B	22,2	804543	804543	
Landcruiser							
Alle/All	2/74-12/91	O.E	B	25,4	804544	804544	
Alle/All	2/74-12/91	O.E	B	23,8	804536	804536	
Liteace							
Alle/All	10/79-1/92	O.E	B	20,6	804533	804533	
Alle/All	92-	O.E	B				
Paseo							
Alle/All	8/95-7/99	O.E	B	17,4	804532	804531	
Picnic							
Alle/All	5/96-	O.E	B	20,0	804534	804534	
Rav4 I							
Alle/All	6/94-6/00	O.E	B	17,4	804557	804557	
Starlet							
Alle/All	2/78-10/84	O.E	B	19,0	804522	804522	
Alle/All	10/84-3/99	O.E	B	17,4	804532	804531	874552 U
Tercel							
Alle/All	5/82-1/88	O.E	B	17,4	804532	804531	874552 U
Tercel 4WD (AL2_)							
Alle/All, 4 WD	10/82-1/88	O.E	B	19,0	804522	804522	
Yaris (_CP10)							
Alle/All (-F)	4/99-8/99	O.E	B	17,4	804555	804556	
Alle/All (-F)	9/99-	O.E	B	17,4			
Alle/All (F)	4/99-	BOS	B	19,0			
Yaris Verso (NC/LP2_)							
Alle/All	11/99-	O.E	B	19,0			
TRABANT							
P 601							
Alle/All	1/66-4/90		F	22,2	805801 U	805801 U	
Alle/All	1/66-4/90		B	15,8	805803 U	805803 U	
1.1							
Alle/All	5/90-12/91		B	19,0	805804 U	805804 U	
VAUXHALL							
Arena							



F/B

∅

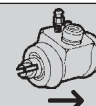
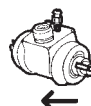

Alle/All	3/98-8/01		B	23,8	803919	803919
Astra						
1.2/1.3 Saloon/Hatchback	80-84	DEL	B	17,4	803623	803623
1.2/1.3 Saloon/Hatchback	80-84	DEL	B	14,3	803620	803620
1.2-1.8 Hatchback CH. ->FE199999	10/84-85	DEL	B	17,4	803623	803623
1.2-1.8 Hatchback CH. GE100001->	85-91	ATE	B	17,4	803628	803628
1.2-1.8 Hatchback CH. ->G2502696	10/84-85	DEL	B	17,4	803623	803623
1.2-1.8 Hatchback CH. G2502697->	85-91	ATE	B	17,4	803628	803628
Astra HD						
Alle/All	80-84	ATE	B	19,0	803611	803611
Alle/All	91-	ATE	B	19,0	803629	803629
Astra						
1.6 & 1.8	81-84	ATE	B	17,4	803625	803625
1.6 Diesel	81-84	ATE	B	17,4	803625	803625
2.0 Hatchback (- 16V)	87-91	ATE	B	19,0	803629	803629
Astra Cabriolet Mk II						
Alle/All	1/87-8/93	ATE	B	17,4	803628	803628
Astra Estate						
Alle/All CH. ->FE199999	10/84-85	ATE	B	19,0	803619	803619
Alle/All CH. GE100001->	85-91	ATE	B	19,0	803629	803629
Alle/All CH. ->G2502696	10/84-85	ATE	B	19,0	803619	803619
Alle/All CH. G2502697->	85-91	ATE	B	19,0	803629	803629
Alle/All CH. ->2518194	80-	DEL	B	19,0	803609 U	803609 U
Alle/All CH. 2518195->	-84	ATE	B	19,0	803619	803619
Astramax						
Astramax	85-91	DEL	B	19,0	803630	803630
Astra						
Alle/All	91-2/98	ATE	B	17,4	803628	803628
Astra Mk IV						
Alle/All (18)	9/98-		B	19,0	803640	803640
VAUXHALL						
Astravan						
Astravan 1.3/1.4 CH. ->FE199999	10/84-85	ATE	B	19,0	803611	803611
Astravan 1.3/1.4 CH. GE100001->	85-91	DEL	B	19,0	803630	803630
Astravan 1.3/1.4 CH. ->2518194	82-	DEL	B	19,0	803609 U	803609 U
Astravan 1.3/1.4 CH. 2518195->	-84	ATE	B	19,0	803619	803619
Astravan 1.6 & 1.6 Diesel CH. ->FE199999	10/84-85	ATE	B	17,4	803625	803625
Astravan 1.6 & 1.6 Diesel CH. GE100001->	85-91	ATE	B	17,4	803631	803631
Astravan 1.6 & 1.6 Diesel	81-84	ATE	B	17,4	803625	803625
Astravan 1.7 Diesel	86-91	DEL	B	19,0	803630	803630



F/B

∅

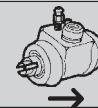
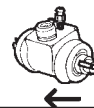

s
t
r
a
v
a
n

k

I
I

A

M

I

Alle/All	1/91-8/98	ATE	B	17,4	803628	803628
Astravan Mk IV Alle/All (18)	8/98-		B	19,0	803640	803640
Brava Pick-up Alle/All	6/90-	O.E	B	25,4	801433	801433
Carlton Alle/All	78-82	ATE	B	19,0	803611	803611
Carlton Estate Alle/All	78-84	ATE	B	22,2	803616	803616
Carlton Mk II Alle/All, ABS	10/78-8/86	ATE	B	22,2	803632 U	803632 U
Alle/All CH. F1000189->	10/78-8/86	DEL	B	19,0	803630	803630
Alle/All	10/78-8/86	ATE	B	15,8	803606	803606
Carlton Mk II Estate Alle/All CH. F1000189->	1/82-8/86	ATE	B	22,2	803632 U	803632 U
Cavalier 1.3 HD	77-81	DEL	B	19,0	803609 U	803609 U
1300	8/77-8/81	ATE	B	15,8	803610	803610



F/B

∅

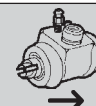
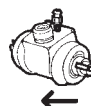

Alle/All (-1300)	3/75-8/81	ATE	B	19,0	803611	803611	
Cavalier Mk II							
Alle/All CH. ->G6000000	9/81-8/88	DEL	B	17,4	803623	803623	
Alle/All CH. G6000001->	9/81-8/88	ATE	B	17,4	803628	803628	
2.0i KAT	9/86-8/88	DEL	B	17,4	803623	803623	
2.0i KAT	9/86-8/88	ATE	B	19,0	803629	803629	
Chevette							
Alle/All	3/75-12/85	DEL	B	19,0	803609 U	803609 U	
Alle/All	3/75-12/85	LUC	B	19,0	803639	803639	
1300	3/75-12/85	ATE	B	19,0	809930	809930	
VAUXHALL							
Combo							
Alle/All	7/94-10/01	DEL	B	19,0	803630	803630	
Alle/All (18)	9/01-		B	19,0	803640	803640	
Corsa							
Alle/All	3/93-9/00	ATE	B	19,0	803629	803629	
Corsa Mk II							
Alle/All (18)	9/00-		B	19,0	803640	803640	
Firenza							
1300	1/71-10/73	LUC	B	17,4	809919	809919	
Frontera							
Alle/All	3/92-10/98	O.E	B	25,4	801433	801433	
Movano							
Alle/All	10/98-	BOS	B	23,8	803641	803642	
Nova							
Alle/All CH. ->G4000000	83-85		B	14,3	803622	803622	
Alle/All CH. ->G4000000	83-85	DEL	B	17,4	803623	803623	
Alle/All CH. G4000001->	85-	ATE	B	17,4	803628	803628	
Tigra							
Alle/All	7/94-	ATE	B	19,0	803629	803629	
Alle/All (18)	7/94-		B	19,0	803640	803640	
Vectra							
1.6 & 2.0 DI 16V	10/95-	ATE	B	19,0	803629	803629	
Viva							
1159/1256	70-78	LUC	B	17,4	809919	809919	



F/B

∅

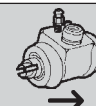
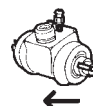

1159/1256	72-78	LUC	B	17,4	809919	809919	
Zafira							
Alle/All	4/99-		B	20,6	803643	803643	
VOLKSVAGEN							
181							
Alle/All	9/69-2/79	ATE	F	22,2	804716	804716	
Alle/All	9/69-2/79	ATE	B	17,4	804718	804718	
1200 Type I							
Alle/All	57-7/64		F	22,2	804714	804714	
Alle/All	57-7/64		B	19,0	804715	804715	
Alle/All	8/64-	ATE	F	22,2	804716	804716	
Alle/All	8/64-12/66	ATE	B	19,0	804717	804717	
Alle/All	1/67-	ATE	B	17,4	804718	804718	
1300 Type I							
Alle/All	8/65-74	ATE	F	22,2	804716	804716	
Alle/All	8/65-7/67	ATE	B	19,0	804717	804717	
Alle/All	8/67-74	ATE	B	17,4	804718	804718	
1302 Type I							
Alle/All	8/70-7/72	ATE	F	23,8	804719	804719	874725 U
Alle/All	8/70-7/72	ATE	B	17,4	804718	804718	
1303 Type I							
Alle/All	8/72-7/74	ATE	F	23,8	804719	804719	874725 U
Alle/All	8/72-7/79	ATE	B	17,4	804718	804718	
1500 Type I							
Alle/All	8/66-7/67	ATE	B	19,0	804717	804717	
Alle/All	8/67-70	ATE	B	17,4	804718	804718	
1500 Type 3 Kombi							
Alle/All	8/64-65	ATE	B	23,8	804719	804719	874725 U
Alle/All	66-67	ATE	B	22,2	804720	804720	
1500 Type 3 Lim.							
Alle/All	63-73	ATE	B	22,2	804720	804720	
1600 Type 3							
Alle/All	8/65-73	ATE	B	22,2	804720	804720	
Caddy I							
Alle/All	8/82-7/92	ATE	B	17,4	804706	804706	
Caddy II (Van)							
Alle/All, (Aluminium) (18)	11/95-	FAG	B	20,6	804738	804738	
Caddy II Pick Up (9U7)							
1.6/1.9D, (-ABS)	10/97-	LUC	B	20,6	804304	804304	
1.6/1.9D, ABS	10/97-	O.E	B	19,0	804303	804303	



F/B

Ø

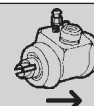
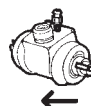

VOLKSWAGEN

Derby

Alle/All (1)	1/77-2/85	ATE	B	14,3	804701	804701
Alle/All (1)	3/85-12/88	ATE	B	15,8	804709	804709
Alle/All (2)	1/77-2/85	ATE	B	17,4	804706	804706
Alle/All (2)	3/85-12/88	LUC	B	19,0	804735	804735

Golf I

Alle/All	4/74-10/83	ATE	B	14,3	804701	804701
Aut.	-10/83	ATE	B	17,4	804706	804706
Gti	-10/83	ATE	B	17,4	804706	804706

Golf II

Alle/All (- 1.6 TD & 1.8)	8/83-91	ATE	B	14,3	804701	804701
1.6 TD	8/83-91	ATE	B	17,4	804706	804706
1.8 & 1.8i Kat, (Aluminium) (18)	8/86-10/91	ATE	B	17,4	804739	804739

Golf II Syncro

Alle/All	8/83-12/91	LUC	B	19,0	804735	804735
----------	------------	-----	---	------	--------	--------

Golf III

1.4	10/91-5/98	ATE	B	15,8	804709	804709
1.6, 55 kW.	10/91-	ATE	B	17,4	804706	804706
1.6, 74 kW. CH. ->1S 246940	7/94-	ATE	B	17,4	804706	804706
1.6, 74 kW. CH. 1S 246941->		LUC	B	19,0	804735	804735
1.6, 74 kW. Aut.	7/94-	ATE	B	17,4	804706	804706
1.8 Man. CH. ->1S 246940	11/91-	ATE	B	17,4	804706	804706
1.8 Man. CH. 1S 246941->		LUC	B	19,0	804735	804735
1.8 Aut. CH. ->1S 246940	11/91-	ATE	B	15,8	804709	804709
1.8 Aut. CH. 1S 246941->		ATE	B	17,4	804706	804706

1.8 Syncro CH. ->1S 400000

1.8 Syncro, (Aluminium) (18)	1/93-8/97	FAG	B	20,6	804738	804738
------------------------------	-----------	-----	---	------	--------	--------

1.9 D Ecomatic CH. ->1S 246940

1.9 TD, 55 kW.	8/93-	ATE	B	15,8	804709	804709
1.9D/TD/Tdi/Sdi	11/91-	ATE	B	15,8	804709	804709
	11/91-	ATE	B	17,4	804706	804706

Golf III Variant

1.4	7/93-6/95	ATE	B	17,4	804706	804706
1.4	7/95-	LUC	B	19,0	804735	804735
1.6/1.8/2.0	7/93-	LUC	B	19,0	804735	804735
1.9D/TD/Tdi/Sdi	7/93-	LUC	B	19,0	804735	804735

Golf I Cabrio

Alle (1)	-93	ATE	B	14,3	804701	804701
Alle (2)	-93	ATE	B	17,4	804706	804706
Alle, (Aluminium) (18)	-93	ATE	B	17,4	804739	804739



F/B

∅

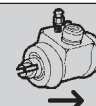
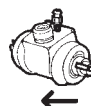

VOLKSWAGEN

Golf III Cabrio

1.6/1.8/1.9 Tdi/2.0 CH. ->1SK016363	7/93-5/98	ATE	B	17,4	804706	804706
1.6/1.8/1.9 Tdi/2.0, (Aluminium) CH. ->1SK016363	7/93-5/98	ATE	B	17,4	804739	804739
1.6/1.8/1.9 Tdi/2.0 CH. 1SK016364-> 1.6	7/93-5/98	LUC	B	19,0	804735	804735
	6/98-	LUC	B	19,0	804735	804735
1.8/1.9 Tdi/2.0 CH. ->1EZSK016363	6/98-	ATE	B	17,4	804706	804706
1.8/1.9 Tdi/2.0, (Aluminium) CH. 1EZSK016364->	6/98-	ATE	B	17,4	804739	804739

Jetta I

Alle/All	8/79-12/83	ATE	B	14,3	804701	804701
1.6 GLi & 1.8	8/79-12/83	ATE	B	17,4	804706	804706

Jetta II

Alle/All (-Syncro)	1/84-12/91	ATE	B	14,3	804701	804701
Alle/All (-Syncro)	1/84-12/91	ATE	B	17,4	804706	804706

Jetta II Syncro

Alle/All	8/87-7/91	LUC	B	19,0	804735	804735
----------	-----------	-----	---	------	---------------	---------------

Kaefer

1.2	1/57-7/65		F	22,2	804714	804714
1.2	1/57-7/65		B	19,0	804715	804715
1.2 & 1.3	8/64-12/69	ATE	F	22,2	804716	804716
Alle/All	1/70-2/76	ATE	F	23,8	804719	804719
1.2/1.3/1.5	1/60-11/73	ATE	B	19,0	804717	804717
Alle/All	1/60-7/79	ATE	B	17,4	804718	804718

LT 28/31

Alle/All	4/75-	ATE	B	25,4	804729	804729
----------	-------	-----	---	------	---------------	---------------

LT 35

Alle/All	4/75-	ATE	B	25,4	804731	804731
----------	-------	-----	---	------	---------------	---------------

LT 40/45

Alle/All (12)	8/78-	ATE	B	25,4	804731	804731
Alle/All (13)	12/82-	FAG	B			

LT 50/55

Alle/All	12/82-	FAG	B			
----------	--------	-----	---	--	--	--

Lupo (6X1, 6E1)

Alle/All	9/98-	ATE	B	17,4	804706	804706
Alle/All, (Aluminium)	9/98-	ATE	B	17,4	804739	804739
Alle/All, (Aluminium)	9/98-	ATE	B	15,8	804740	804740

Passat

1.3	5/73-7/84	ATE	B	14,3	804701	804701
1.3	8/84-7/85	ATE	B	15,8	804709	804709



F/B

∅

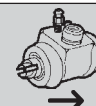
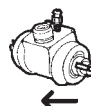

1.3 HD VOLKSWAGEN	8/84-7/85	ATE	B	17,4	804706	804706
Passat						
1.5	5/73-8/75	ATE	B	14,3	804701	804701
1.5 Aut	5/73-8/75	ATE	B	17,4	804706	804706
1.5 Diesel	8/77-7/80	ATE	B	14,3	804701	804701
1.5 Aut. Diesel	8/77-7/80	ATE	B	17,4	804706	804706
1.6	9/75-7/81	ATE	B	14,3	804701	804701
1.6	8/81-7/84	ATE	B	15,8	804709	804709
1.6	8/84-3/88	ATE	B	15,8	804709	804709
1.6 (18)	4/88-9/89		B	19,0	804306	804306
1.6	10/89-		B	20,6	804736	804736
1.6i	9/75-7/80	ATE	B	17,4	804706	804706
1.6 Aut.	9/75-7/84	ATE	B	17,4	804706	804706
1.6 Aut. HD	8/84-3/88	ATE	B	17,4	804706	804706
1.6 Diesel	8/80-7/81	ATE	B	14,3	804701	804701
1.6 Diesel	8/81-7/84	ATE	B	15,8	804709	804709
1.6 Diesel	8/84-3/88	ATE	B	14,3	804701	804701
1.6 Aut. Diesel	8/80-7/84	ATE	B	17,4	804706	804706
1.6 Aut. Diesel HD	8/84-3/88	ATE	B	17,4	804706	804706
1.6 TD	12/81-7/84	ATE	B	17,4	804706	804706
1.6 TD	8/84-3/88	ATE	B	17,4	804706	804706
1.6 TD	4/88-10/93		B	20,6	804736	804736
1.8 (- GT)	1/83-7/84	ATE	B	15,8	804709	804709
1.8	8/84-3/88	ATE	B	15,8	804709	804709
1.8	4/88-96		B	20,6	804736	804736
1.8i Aut.	1/83-7/84	ATE	B	17,4	804706	804706
1.8 Aut. HD	8/84-3/88	ATE	B	17,4	804706	804706
1.9	1/81-7/81	ATE	B	15,8	804709	804709
1.9	8/81-7/83	ATE	B	17,4	804706	804706
1.9 Diesel	5/89-10/93		B	20,6	804736	804736
1.9 TD	3/91-96		B	20,6	804736	804736
2.0	8/83-7/84	ATE	B	17,4	804706	804706
2.0i	8/84-3/88	ATE	B	17,4	804706	804706
2.2i	8/85-3/88	ATE	B	17,4	804706	804706
1.6/1.6 TD1.8/1.9 D/1.9 TD, (Aluminium)	2/88-8/96	FAG	B	20,6	804738	804738
Passat Variant						
1.3	5/73-7/85	ATE	B	17,4	804706	804706
1.5	5/73-8/75	ATE	B	17,4	804706	804706
1.5 Diesel	8/77-7/80	ATE	B	17,4	804706	804706



F/B

∅

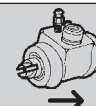
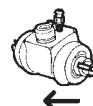

1.6	9/75-3/88	ATE	B	17,4	804706	804706
1.6	4/88-		B	20,6	804736	804736
VOLKSWAGEN						
Passat Variant						
1.6 Diesel & 1.6 TD	8/80-3/88	ATE	B	17,4	804706	804706
1.6 TD	4/88-10/93		B	20,6	804736	804736
1.8	1/83-3/88	ATE	B	17,4	804706	804706
1.8i	4/88-10/93	ATE	B	20,6	804736	804736
1.9	1/81-7/81	ATE	B	15,8	804709	804709
1.9	8/81-7/83	ATE	B	17,4	804706	804706
1.9 TD	3/91-10/93		B	20,6	804736	804736
2.0 & 2.2	8/83-3/88	ATE	B	17,4	804706	804706
1.6/1.6 TD/1.8/1.9 D/1.9 TD, (Aluminium)	2/88-96	FAG	B	20,6	804738	804738
Polo						
Alle/All (1)	3/75-2/85	ATE	B	14,3	804701	804701
Alle/All (1)	3/85-9/94	ATE	B	15,8	804709	804709
Alle/All (2)	3/75-2/85	ATE	B	17,4	804706	804706
Alle/All (2)	3/85-9/94	LUC	B	19,0	804735	804735
Polo (6NF)						
Alle/All	10/94-	ATE	B	17,4	804706	804706
Alle/All, (Aluminium) (18)	10/94-	ATE	B	17,4	804739	804739
1.9 SDi, ABS	10/94-	LUC	B	19,0	804735	804735
Polo (6N1)						
Alle/All	10/94-10/99	ATE	B	17,4	804706	804706
Alle/All, (Aluminium) (18)	10/94-10/99	ATE	B	17,4	804739	804739
Polo (6N2)						
Alle/All	10/99-9/01	ATE	B	17,4	804706	804706
Alle/All, (Aluminium) (18)	10/99-9/01	ATE	B	17,4	804739	804739
Alle/All, (-ABS)	10/99-9/01	LUC	B	19,0	804735	804735
Polo Classic (6KV2)						
Alle/All	12/95-9/01	LUC	B	19,0	804735	804735
Alle/All, (Aluminium) (18)	12/95-9/01	ATE	B	17,4	804739	804739



F/B

Ø

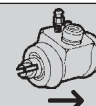
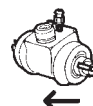

Polo Classic 75 (6KV2)

1.4 16V

10/99-9/01

ATE

B

17,4

804706

804706

Polo Variant (6KV5)

Alle/All

5/97-9/01

ATE

B

19,0

804735

804735

Polo (9N_)

Alle/All, (Aluminium) (18)

10/01-

ATE

B

17,4

804739

804739

VOLKSWAGEN

Santana (32B)

Alle/All CH. ->ZF127903

4/93-

ATE

B

14,3

804701

804701

Alle/All CH. ->ZF127903

4/93-

ATE

B

17,4

804706

804706

1.6/1.6 D/1.8 CH. ZF127904->

ATE

B

15,8

804709

804709

Scirocco

1.1/1.3

74-7/81

ATE

B

14,3

804701

804701

1.3

8/81-7/83

ATE

B

17,4

804706

804706

1.3

8/83-10/83

ATE

B

14,3

804701

804701

1.3

11/83-7/84

ATE

B

17,4

804706

804706

1.5

74-7/81

ATE

B

14,3

804701

804701

1.5

8/81-7/83

ATE

B

17,4

804706

804706

1.6

75-7/81

ATE

B

14,3

804701

804701

1.6

8/81-7/83

ATE

B

17,4

804706

804706

1.6

8/83-10/83

ATE

B

14,3

804701

804701

1.6

11/83-

ATE

B

17,4

804706

804706



F/B

Ø

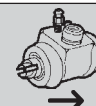
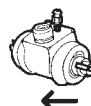

1.8	8/83-10/83	ATE	B	14,3	804701	804701
1.8	11/83-	ATE	B	17,4	804706	804706
Alle/All i mod.		ATE	B	17,4	804706	804706
Aut.		ATE	B	17,4	804706	804706
Taro						
Alle/All	4/89-3/97	O.E	B	22,2	804541	804541
Transporter T2						
Alle/All	8/68-7/79	ATE	B	23,8	804728	804728
Transporter T3						
Alle/All	5/79-7/92	ATE	B	23,8	804728	804728
Transporter T4						
Alle/All	7/90-		B	20,6	804737	804737
Vento						
1.4/1.6/1.8/1.9 D/1.9 TD CH. ->1S430000	1/92-9/98	ATE	B	17,4	804706	804706
1.4/1.6/1.8/1.9 D/1.9 TD (Aluminium) CH ->1S430000	1/92-9/98	ATE	B	17,4	804739	804739
1.6/1.8/1.9 D/1.9 TD/1.9 TDi CH. 1S430001->	1/92-9/98	LUC	B	19,0	804735	804735
VOLVO						
Amazon 122S, B18						
Alle/All	5/61-6/64	LUC	B	25,4	804804	804804
Alle/All (3)	5/61-6/64	LUC	B		899901	899901
Amazon B18						
Alle/All	6/64-6/65	LUC	B	25,4	804804	804804
Alle/All	7/65-9/68	LUC	B	22,0	804805	804805
Amazon Estate B18						
Alle/All	6/64-9/68	LUC	B	25,4	804804	804804
Alle/All (3)	6/64-9/68	LUC	B		899901	899901
Amazon B20						
Alle/All	9/68-70	LUC	B	22,2	804806	804806
340						
L/DL/GL/Diesel	8/82-	LUC	B	19,0	809920	809920
DL 1.7	6/85-	LUC	B	20,6	804808	804808
343/345						
L/DL/GL	2/76-	LUC	B	19,0	809920	809920
360						
GL/GLE/GLS/GLT	8/82-	LUC	B	20,6	804808	804808
440/460						
Alle/All	9/88-	LUC	B	20,6	804812	804811

WARTBURG

Hjelpvisninger se side 2 / Notekey see page 2 / Hinweise siehe Blatt 2

Alle/All	6/66-2/75		F	25,4	804901 U	804902 U
----------	-----------	--	---	------	-----------------	-----------------



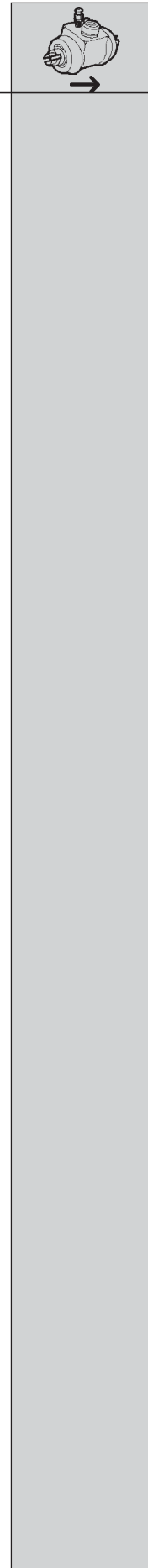
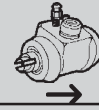
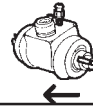

F/B



**Anvendelsesliste
Buyer's guide
Numerische Liste**



				
801001	Alfa Romeo	33	7/83-8/86	17,4
801002	Alfa Romeo	33	7/83-8/86	17,4
801005	Alfa Romeo	33	9/85-9/94	17,4
801006	Alfa Romeo	33	9/85-9/94	17,4
801007	Alfa Romeo	33/Arna	84-89	19,0
801008	Alfa Romeo	33/Arna	84-89	19,0
801201	Rover Group	Austin Mini MK I	67-84	24,0
801202	Rover Group	Austin Mini MK I	67-84	24,0
801204	Rover Group	Austin Mini MK I	-7/78	14,0
801205	Rover Group	Austin/Austin MK II & III/MGB GT/MGB Tourer & Roadster	62-82	20,3
801207	Rover Group	Austin Maxi	11/78-81	14,3
801214	Rover Group	Austin Allegro	73-84	14,3
801215	Rover Group	Morris Minor	56-71	24,0
801216	Rover Group	Morris Minor	56-71	24,0
801217	Rover Group	Morris Minor	62-71	19,0
801220	Rover Group	Austin/Austin MK I / II & III	5/65-75	18,0
801222	Rover Group	Austin Princess	4/76-10/82	14,3
801225	Rover Group	Austin Metro/Rover 100/Rover Maestro	10/80-1/95	17,4
801226	Rover Group	Austin Maestro	83-95	15,8
801227	Rover Group	Austin Maestro	83-95	15,8
801228	Rover Group	Austin Montego	4/84-8/91	17,4
801229	Rover Group	Austin Montego	4/84-8/91	17,4
801409	Bedford	CF Van	77-	23,8
801410	Bedford	CF Van	77-	23,8
801432	Isuzu	Trooper	83-	22,2
801433	Isuzu	Campo(TFR/TFS)/KB/KBD/Trooper	81-12/91	25,4
	Opel	Campo/Frontera A	8/91-10/98	25,4
	Vauxhall	Brava Pick-up/Frontera	6/90-	25,4
801502	BMW	02 Series(E10)/2000-3.2 (E9)/5 Series (E12)	70-5/81	22,2
801503	BMW	02 Series (E6)&(E10)/1500-2000 Series	66-75	17,4
801504	BMW	02 Series (E6)&(E10)/1500-2000 Series	9/67-7/77	15,8
801506	BMW	3 Series (E30)	9/82-10/93	20,6
801507	BMW	5 Series (E28)	9/84-6/90	20,6
801508	BMW	3 Series (E30)	9/85-6/94	22,2
801509	BMW	5 Series (E34)	8/89-9/95	23,8
801510	BMW	3 Series (E36)	9/90-8/00	23,8
801511	BMW	3 Series (E36)	3/94-8/00	22,2
801813	Talbot	1307-1510/Horizon/Solara	7/75-7/86	20,6
801820	Talbot	Avenger/Simca Sunbeam	2/70-7/81	18,0
801909	Citroen	2 CV/Dyane/Mehari	6/70-	28,6
801910	Citroen	2 CV/Dyane/Mehari	6/70-	17,4
801911	Citroen	2 CV/3 CV/AMI & AMI Break/Dyane/Mehari	7/69-	16,0
801918	Citroen	LNA/Visa	9/78-	20,6
801918	Peugeot	104		20,6
801919	Citroen	AX	9/86-12/98	19,0
801920	Citroen	AX	9/86-12/98	19,0
801921	Citroen	AX	9/86-12/98	19,0
801923	Citroen	ZX	3/91-8/92	20,6
801924	Citroen	ZX	3/91-8/92	20,6
801925	Citroen	Visa	84-89	22,2
801926	Citroen	Evasion/Jumpy	6/94-	19,0
	Fiat	Scudo/Ulysse	6/94-	19,0
	Lancia	Zeta	5/95-9/02	19,0
	Peugeot	806/Expert	6/94-	19,0



**Anvendelsesliste
Buyer's guide
Numerische Liste**



				\emptyset
801927	Citroen	Xsara/ZX	2/94-	20,6
	Peugeot	306/306 Break	5/93-	20,6
801928	Citroen	C 25	2/89-	22,2
	Fiat	Talento	9/89-	22,2
	Peugeot	J 5	2/89-	22,2
801929	Citroen	Berlingo/Xsara	7/96-	22,2
	Peugeot	Partner	6/96-	22,2
801930	Citroen	Saxo/Xsara/ZX	7/95-	20,6
	Peugeot	106 II/306	5/95-	20,6
	Renault	Laguna/Megane Grandtour/Megane Scenic/Scenic	7/95-	20,6
801931	Citroen	AX	5/91-12/96	
	Renault	Twingo	3/94-	
801932	Citroen	Xsara	10/97-	22,0
	Peugeot	306 Break	2/97-	22,0
801933	Citroen	C3	02/02-	19,0
801934	Citroen	C3	02/02-	19,0
801935	Citroen	C3	02/02-	20,8
802201	Nissan	Cherry (E10)/Datsun 100A	9/70-8/80	17,4
802202	Nissan	Cherry (E10)/Datsun 100A	9/70-8/80	17,4
802209	Nissan	1000 B10/1200 B110	66-73	20,0
802211	Nissan	Datsun (120)	5/73-11/77	20,0
802212	Nissan	Datsun (120)	5/73-11/77	20,0
802217	Nissan	Bluebird (T72/T12)/Bluebird (U11/WU11)/Datsun (140/160/180)/ Prairie (M11)/Primera Wagon (W10)/Silvia (S110)/ Sunny (140Y,150Y)/Vanette(C22)	1/70-3/98	20,6
802222	Nissan	Cherry (N12)/Sunny I (B11)/Sunny II (N13,B12)	3/82-10/91	17,4
802224	Nissan	Prairie (M10)/Stanza (T11)	8/81-12/87	17,4
802225	Nissan	Micra (K10)	12/82-7/92	15,9
802226	Nissan	Patrol (K160/W160)/Patrol (K260/W260)	11/79-9/89	22,2
802229	Nissan	Pick up (720)/Urvan (E23)	1/82-3/86	17,4
802231	Nissan	Pick up (720)	7/80-11/81	17,0
802232	Nissan	Pick up (720)	4/83-3/86	16,0
802233	Nissan	Pick up (720)	12/81-3/83	14,3
802234	Nissan	Pick up (D21)	9/85-8/91	17,4
802235	Nissan	Pick up (D21)/Urvan (E23)	9/85-8/88	19,0
802236	Nissan	Pick up (D21)	9/85-7/89	15,0
802237	Nissan	Prairie (M11)/Prairie (NM10)/Vanette Bus (KC120)/Vanette Kasse (C22)	1/83-1/95	19,0
802238	Nissan	Bluebird (T72/T12)/Bluebird (U11/WU11)/Laurel/Prairie (M11)/ Prairie (NM10)/Silvia (S12)	7/81-12/92	22,2
802239	Nissan	Primera (P10)	10/90-1/96	20,6
802240	Nissan	Primera (P10)	10/90-1/96	20,6
802241	Nissan	100 NX (B13)/Almera I (N15)/Sunny III (N14)	3/90-7/00	15,8
802242	Nissan	Prairie (M11)/Sunny III Wagon (Y10)/Vanette Bus (C22)	11/90-	17,4
802243	Nissan	Urvan (E24)	1/87-	20,6
802244	Nissan	Micra (K11)	8/92-2/03	17,4
802245	Nissan	Patrol (K260/W260)/Patrol I (Y60)/Patrol II (Y61)	9/88-	25,4
802246	Nissan	Pick up (D21)	8/89-	20,6
802247	Ford	Maverick	2/93-8/96	22,2
	Ford USA	Maverick	2/93-8/96	22,2
	Nissan	Terrano II (R20)	1/90-	22,2
802248	Ford	Maverick	2/93-8/96	23,8
	Ford USA	Maverick	2/93-4/98	23,8
	Nissan	Serena (C23M)/Terrano II (R20)/Vanette Cargo	1/90-	23,8
802249	Nissan	Primera (P11)	9/96-	

Anvendelsesliste
Buyer's guide
Nummerische Liste



				
802303	Fiat	600/850	3/55-73	22,2
802304	Autobianchi	A 112	71-12/85	19,0
802304	Fiat	126/127/128/147/500/600/850/Fiorino (147)	3/55-6/96	19,0
802304	Lada	1200-1600	1/70-12/78	19,0
802304	Lancia	A112	3/81-10/82	19,0
802304	Seat	Fura	1/82-12/86	19,0
802304	Yugo	101	6/73-12/93	19,0
802306	Lada	110/111/112/1200-1600/Nova/Samara	1/78-	20,6
802313	Fiat	131/132	10/74-8/82	22,2
802320	Fiat	Ritmo I	5/78-83	17,4
802320	Lancia	Delta I	9/79-8/92	17,4
802321	Lada	1200-1600/Niva	12/76-	20,6
802323	Fiat	Daily 35	79-	17,0
802324	Fiat	900/Panda	1/78-1/86	15,8
802328	Autobianchi	Y 10	3/85-	19,0
802328	Fiat	127/147/Cinquecento/Duna/Fiorino (146 Uno)/Fiorino (147)/ Panda/Regata/Ritmo/Ritmo II/Seicento/Uno	1/80-	19,0
802328	Lancia	A112/Delta I/Prisma/Y10 (156)	9/79-12/95	19,0
802328	Seat	Marbella	8/86-10/98	19,0
802329	Fiat	Panda	9/82-7/84	15,7
802331	Fiat	Ritmo I	6/82-11/82	17,4
802331	Lancia	Delta I/Prisma	9/79-8/92	17,4
802331	Seat	Ibiza I/Malaga/Ronda	7/82-	17,4
802333	Fiat	Tipo	2/88-2/93	15,0
802334	Fiat	Tempra/Tipo	2/88-8/96	17,4
802335	Fiat	Tempra/Tipo	2/88-2/93	19,0
802335	Lancia	Dedra	8/89-7/99	19,0
802336	Fiat	Punto	7/93-	20,6
802336	Lancia	Y (840A)	3/96-	20,6
802337	Fiat	Punto	7/93-	20,6
802337	Lancia	Y (840A)	3/96-	20,6
802338	Alfa Romeo	145/146	10/94-1/01	22,2
802338	Fiat	Tempra/Tipo	3/93-	22,2
802338	Lancia	Delta II	6/93—8/99	22,2
802340	Citroen	Jumper	2/94-4/02	25,4
802340	Fiat	Ducato	2/94-4/02	25,4
802340	Peugeot	Boxer 10 &14	3/94-4/02	25,4
802341	Citroen	Jumper	2/94-4/02	27,0
802341	Fiat	Ducato	2/94-4/02	27,0
802341	Peugeot	Boxer 14	3/94-4/02	27,0
802342	Citroen	Jumper	2/94-4/02	28,6
802342	Fiat	Ducato	2/94-4/02	28,6
802342	Peugeot	Boxer 18	3/94-4/02	28,6
802343	Alfa Romeo	145	9/94-1/01	20,6
802343	Fiat	Marea/Multipla/Palio (Weekend)/Tempra/Tipo	3/92-	20,6
802344	Fiat	Brava/Bravo/Marea	6/95-	22,2
802345	Fiat	Brava/Bravo/Marea	6/95-	22,2
802346	Fiat	Punto/Regata	10/83-	20,6
802347	Fiat	Punto	8/99-	22,0
802348	Fiat	Doblo	3/01-	20,64
802349	Fiat	Fiorino (146 Uno)	1/93-	20,64
802350	Fiat	Palio	4/96-	19,05
802351	Fiat	Siena	4/96-	19,05
802353	Fiat	Panda (169)	9/03-	20,6
802354	Fiat	Punto III (188)	7/03-	20,6
802505	Ford	Taurus	62-71	17,4

**Anvendelsesliste
Buyer's guide
Numerische Liste**



802506	Ford	Cortina/Escort III & IV & VI/Focus/Orion/Orion II/Puma/Taurus	8/71-	19,0
802507	Ford	Capri/Cortina/Escort II & III & IV/Granada/Ka/Orion/Taurus	1/74-	17,4
802507	Mazda	121 III (JASM,JBSM)	3/96-	17,4
802508	Ford	Cortina/Taurus	74-7/82	19,0
802509	Ford	Cortina/Focus/Granada/Sierra	70-	20,6
802513	Ford	Courier/Escort '81/Escort III/Escort IV/Orion II/Fiesta IV/Granada/Orion/Sierra	1/74-	22,2
802516	Ford	Capri/Escort II	11/74-8/80	20,6
802518	Ford	Capri/Cortina	66-10/74	17,4
802522	Ford	Capri	11/74-6/76	18,0
802523	Ford	Fiesta I	6/76-7/83	17,4
802524	Ford	Fiesta I	6/76-7/83	15,8
802530	Fiat	Daily I 35-12	1/90-4/96	19,0
802530	Ford	Transit	9/68-12/70	19,0
802531	Ford	Transit	7/76-	20,3
	Rover Group	MG RV8	93-	20,3
802532	Ford	Transit	76-85	25,0
802533	Ford	Transit	76-85	25,0
802536	Ford	Sierra	8/82-12/86	20,6
802537	Ford	Escort II	12/74-8/80	17,8
802539	Ford	Fiesta II	8/83-4/89	17,4
802540	Ford	Transit	86-91	20,3
802541	Ford	Transit	86-91	22,2
802542	Ford	Transit	86-91	22,2
802543	Ford	Transit	86-91	22,2
802544	Ford	Sierra/Transit	86-	23,8
802545	Ford	Sierra/Transit	86-	23,8
802546	Ford	Transit	86-91	25,4
802547	Ford	Transit	86-91	25,4
802549	Ford	Fiesta III	2/89-95	17,4
802550	Ford	Fiesta III	2/89-95	22,2
802551	Ford	Sierra	1/87-	22,0
802552	Ford	Escort IV/Orion III/Escort VII/Focus/Sierra	1/87-	20,6
	Land Rover	Freelander	2/98-	20,6
802553	Ford	Escort IV/Orion III/Escort VII/Fiesta IV	8/90-	19,0
	Mazda	121 III (JASM,JBSM)	3/96-	19,0
802554	Ford	Escort IV/Orion III/Escort VII/Focus	8/90-	22,2
802555	Ford	Fiesta II	2/84-4/89	15,0
802556	Ford	Fiesta II	2/84-4/89	20,6
802557	Ford	Fiesta III	5/89-12/94	19,0
802558	Ford	Fiesta I	10/81-7/83	19,0
802559	Ford	Transit	88-	20,3
802560	Ford	Transit	88-	20,3
802561	Ford	Mondeo	1/93-5/94	20,6
802562	Ford	Mondeo	1/93-11/00	22,2
802563	Ford	Transit	9/91-	22,2
802564	Ford	Transit	9/91-	20,6
802565	Ford	Transit	9/91-	25,4
802566	Ford	Mondeo	6/94-11/00	22,2
802567	Ford	Fiesta V/Ka	11/01-	19,05
802568	Ford	Transit	3/00-	25,4
802601	Honda	Accord/Civic	72-80	17,4
802602	Honda	Civic	76-80	15,9
802605	Honda	Accord	79-81	19,0
802606	Honda	Accord/Aerodeck	86-	20,6

**Anvendelsesliste
Buyer's guide
Numerische Liste**



802607	Honda	Civic	88-	19,0
802608	Honda	Accord	82-85	19,0
802609	Honda	Civic/Jazz (AA)	82-10/86	19,0
802610	Honda	Civic/Jazz (AA)	82-10/86	19,0
802611	Honda	Civic	84-89	19,0
802612	Honda	Civic	84-89	19,0
802613	Honda	Civic/HR-V	90-	19,0
802614	Honda	Civic/HR-V	90-	19,0
802615	Honda	Civic	92-	19,0
802616	Honda	Civic	92-	19,0
802617	Honda	Accord	90-92	19,0
802618	Honda	Accord	90-92	19,0
802619	Honda	Accord VII (CG)	10/98-	
802620	Honda	Accord VII (CG)	10/98-	
802621	Honda	Civic VI (EU_,EP_)	2/01-	19,0
802622	Honda	Civic VI (EU_,EP_)	2/01-	19,0
802623	Honda	CR-V I (RD1,RD3)/CR-V II/Civic VI (EU_,EP_)	1/99-	20,0
802624	Honda	CR-V I (RD1,RD3)/CR-V II/Civic VI (EU_,EP_)	1/99-	20,0
803002	Mitsubishi	L300/Pajero I	9/81-	20,6
803003	Mitsubishi	L300/Pajero I	9/81-	20,6
803004	Mitsubishi	Colt I (C1_A)/Colt II (C1_A)/Colt III (C5_A)/Lancer III/ Lancer IV (C6_A/C7_A)/Space Runner/Space Wagon	12/78-8/99	19,0
803011	Mitsubishi	Cordia (A21_A)/Galant III (E1A_)/Galant IV (E3A_)/Lancer V (CD4A)/Tredia	9/82-	17,4
803012	Mitsubishi	L200 (K_4T)/L300/Pajero I/Space Gear	5/86-	22,2
803013	Mitsubishi	L200 (K_4T)/L300/Pajero I/Space Gear	5/86-	22,2
803014	Mitsubishi	L200 (K_4T)/L200 (K6_T)/Pajero II	11/86-	23,8
803015	Mitsubishi	L200 (K_4T)/L200 (K6_T)/Pajero II	11/86-	23,8
803016	Mitsubishi	Lancer III (Wagon)	1/84-6/92	20,6
803017	Mitsubishi	Colt III (C5_A)/Colt IV (CA_A)/Colt V (CJ_A)/Lancer IV (C6_A/C7_A)/ Lancer V (CB/D_A)/Lancer VI/Space Runner	6/90-	19,0
803018	Mitsubishi	Colt V (CJ_A)/Galant IV (E3A_)/Lancer VI	7/89-	17,4
803019	Mitsubishi	Carisma/Space Star	6/95-9/98	??
803020	Mitsubishi	Space Star	10/98-5/00	19,05
803201	Mazda	1300/616	70-2/78	19,0
803202	Mazda	1300/1600/1800/818	69-8/76	17,0
803205	Mazda	1000/1300/323 I (FA)	1/75-5/80	19,0
803206	Mazda	626 I (CB)/929	7/75-12/80	20,6
803207	Mazda	626 I (CB)/929	7/75-12/80	20,6
803209	Mazda	929 L	4/78-9/80	22,0
803215	Mazda	323 II (BD)	11/80-10/89	17,4
803217	Mazda	323 I Wagon (FA)	5/78-5/86	19,0
803220	Mazda	B-Serie	10/81-84	22,2
803221	Mazda	626 II (GC)	11/82-9/87	19,0
803223	Mazda	B-Serie/E 2000/E 2200	1/84-	19,0
803225	Mazda	E 2000/E 2200	1/84-	17,4
803226	Mazda	E 2000/E 2200	1/84-	17,4
803227	Mazda	323 C IV (BG)/323 F IV (BG)/323 S IV (BG)/626 III (GD)/626 III (GV)/ 626 IV (GE)/626 V (GF)/MX3	6/87-	17,4
803228	Mazda	323 III (BF)/323 III Wagon (BW)	8/85-3/93	17,4
803229	Mazda	323 C V (BA)/323 F V (BA)/323 P V/323 S V (BA)	7/94-	19,0
803230	Mazda	121 I&II (DA&DB)	10/87-3/96	15,9
803231	Mazda	Demio	8/98-	17,46
803307	BMW	3 Series (E21)	67-	22,0
803307	MB	Hanomag	67-	22,0
803312	MB	T1 (601/602)	4/77-2/96	18,8
803313	MB	MB 100 Series	2/88-2/96	25,4
803314	MB	GD (W460)/GD (W461)/GD (W463)	3/79-	17,5

**Anvendelsesliste
Buyer's guide
Numerische Liste**



803315	MB	A-Klasse	7/97-	17,50
803316	MB	A-Klasse	7/97-	19,05
803317	Smart	Cabrio/City Coupe/Crossblade/Roadstar/Roadstar coupe	7/98-10/99	17,46
803318	Smart	Cabrio/City Coupe/Crossblade/Roadstar/Roadstar coupe	7/98-10/99	17,46
803319	Smart	Cabrio/City Coupe/Crossblade/Roadstar/Roadstar coupe	11/99-	22,0
803320	Smart	Cabrio/City Coupe/Crossblade/Roadstar/Roadstar coupe	11/99-	22,0
803401	Hyundai	Accent	10/94-1/00	19,0
803402	Hyundai	Accent	10/94-1/00	19,0
803403	Hyundai	H 100	7/93-	20,6
803404	Hyundai	H 100	7/93-	20,6
803405	Hyundai	Coupe/Lantra I/Lantra II/Sonata	10/90-	19,0
803406	Hyundai	Coupe/Lantra I/Lantra II/Sonata	10/90-	19,0
803407	Hyundai	Pony/S Coupe	7/90-	20,6
803408	Hyundai	Pony/S Coupe	7/90-	20,6
803409	Hyundai	Pony/S Coupe	10/89-6/92	20,6
803411	Hyundai	Atos	2/98-	
803412	Hyundai	Atos	2/98-	
803501	Kia	Sephia	9/93-	19,0
803502	Kia	Sportage	4/94-6/97	20,64
803503	Kia	Pregio	10/97-	19,05
803504	Kia	Pregio	10/97-	19,05
803505	Kia	Sportage	6/97-	20,64
803603	Opel	Kadett A/Kadett B/Kadett C/Olympia A	62-7/79	15,8
803604	Opel	Kadett B/Kadett C	65-7/79	23,8
803605	Opel	Kadett B/Kadett C	65-7/79	23,8
803606	Opel	Ascona A/Kadett B/Manta A/Olympia A/Rekord B/C/Rekord D/Rekord E	65	15,8
	Vauxhall	Carlton Mk II	10/78-8/86	15,8
803608	Opel	Kadett D	82-	17,4
	Vauxhall	Astra/Cavalier Mk II	80-8/88	17,4
803609	Opel	Kadett D	8/79-	19,0
	Vauxhall	Astra Estate	3/75-	19,0
803610	Opel	Ascona A/Ascona B/Manta A	70-	15,8
	Vauxhall	Cavalier	8/77-8/81	15,8
803611	Opel	Ascona A&B/Kadett D/Manta A&B/Rekord D&E	72-	19,0
	Vauxhall	Astra HD/Astravan/Carlton/Cavalier	3/75-85	19,0
803616	Opel	Commodore B&C/Rekord E/Rekord E Kombi	1/72-	22,2
	Vauxhall	Carlton Estate	78-84	22,2
803619	Opel	Kadett D/Kadett E Kombi	-7/85	19,0
	Vauxhall	Astra Estate/Astravan	-85	19,0
803620	Opel	Kadett D&E	8/79-85	14,3
	Vauxhall	Astra	80-84	14,3
803622	Opel	Corsa A	9/82-7/86	14,3
	Vauxhall	Nova	83-85	14,3
803623	Opel	Ascona C/Corsa A/Kadett D&E	8/79-7/86	17,4
	Vauxhall	Cavalier Mk II/Nova	83-8/88	17,4
803625	Opel	Commodore A/Kadett D/Kadett E Kombi	8/67-7/85	17,4
	Vauxhall	Astra/Astravan	81-85	17,4
803627	Opel	Corsa A/Kadett E	85-	14,3
803628	Daewoo	Lanos	5/97-	17,4
	Opel	Ascona C/Astra F/Corsa A/Kadett E	85-	17,4
	Vauxhall	Astra/Astra Cabriolet Mk II/Astravan Mk III/Cavalier Mk II/Nova	85-	17,4
803629	Daewoo	Espero/Lanos/Nexia	2/95-	19,0
803629	Opel	Ascona C/Astra F/Astra F Caravan/Kombi/Astra G/Corsa B/ Corsa C/Kadett E/Kadett E Kombi/Tigra/Vectra A&B	8/85-	19,0
	Vauxhall	Astra/Astra Estate/Astra HD/Cavalier Mk II/Corsa/Tigra/Vectra	85-	19,0
803630	Opel	Combo (71_)/Kadett E Kombi/Rekord E		19,0
	Vauxhall	Astramax/Astravan/Carlton Mk II/Combo	10/78-10/01	19,0

**Anvendelsesliste
Buyer's guide
Numerische Liste**



				\emptyset
803631	Opel	Kadett E Kombi	8/85-9/91	17,4
	Vauxhall	Astravan	85-91	17,4
803632	Opel	Rekord E/Rekord E Kombi		22,2
	Vauxhall	Carlton Mk II/Carlton Mk II Estate	10/78-8/86	22,2
803639	Vauxhall	Chevette	3/75-12/85	19,0
803640	Opel	Astra F/Astra F Caravan/Kombi/Astra G/Combo (Kasse/Wagon)/ Combo Tour/Corsa B&C/Tigra/Vectra A&B	9/88-	19,0
803640	Vauxhall	Astra Mk IV/Astravan Mk IV/Combo/Corsa Mk II/Tigra	9/90-	19,0
803641	Opel	Movano	7/98-	23,81
	Renault	Master II	7/98-	23,81
	Vauxhall	Movano	10/98-	23,81
803642	Opel	Movano	7/98-	23,81
	Renault	Master II	7/98-	23,81
	Vauxhall	Movano	10/98-	23,81
803731	Peugeot	205 I & II/205 Kasse	2/83-	19,0
803732	Peugeot	205 I & II/205 Kasse	2/83-	19,0
803739	Peugeot	205 I & II/205 Kasse	2/83-	19,0
803740	Peugeot	205 I & II/205 Kasse	2/83-	19,0
803741	Peugeot	309 II	7/89-12/93	20,6
803742	Peugeot	309 II	7/89-12/93	20,6
803743	Peugeot	405 I & II	1/87-10/95	20,6
803744	Peugeot	405 I & II	1/87-10/95	20,6
803745	Peugeot	504 Break/Cabriolet/Coupe/Pick up/505 Break	4/71-12/93	22,2
	Renault	Espace II/Espace III/Safrane I	5/92-	22,2
803746	Peugeot	205 I & II	12/84-9/98	19,0
803747	Citroen	Saxo	3/96-	19,0
	Peugeot	106 I&II	9/91-	19,0
803748	Citroen	Saxo	3/96-	19,0
	Peugeot	106 I&II	9/91-	19,0
803749	Peugeot	106 I	9/91-4/96	19,0
803750	Peugeot	406	11/95-	20,6
803751	Peugeot	406	11/95-	20,6
803752	Peugeot	406	11/95-	20,6
803753	Peugeot	406	11/95-	20,6
803754	Peugeot	405 I & II/405 II Break	1/87-10/96	20,6
803755	Citroen	C 2/Saxo/Xsara	3/96-	20,6
803755	Peugeot	106 II/206/306	3/96-	20,6
803901	Renault	4/5/6	10/62-6/90	23,8
803902	Renault	4/5/6	10/62-6/90	23,8
803903	Renault	4/5	10/62-	19,0
803904	Renault	4/5/6	8/70-6/90	22,2
803905	Renault	4/5/6	8/70-6/90	22,2
803906	Renault	4	10/62-6/90	21,0
803910	Dacia	1310	5/83-	
803911	Renault	12/15/16/17	9/65-10/80	22,0
803917	Renault	18 Break/Fuego/Trafic		22,0
803919	Opel	Arena/Frontera A	3/92-8/01	23,8
	Renault	Trafic	3/80-	23,8
	Vauxhall	Arena	3/98-8/01	23,8
803922	Renault	12	10/69-8/80	22,2
803925	Renault	Clio I	4/91-9/98	20,6
803926	Daewoo	Lanos	5/97-	19,0
	Renault	Clio I	4/91-9/98	20,6
803927	Renault	19 I	1/88-12/92	20,6

**Anvendelsesliste
Buyer's guide
Numerische Liste**



				\emptyset
803928	Renault	19 I	1/88-12/92	20,6
803929	Citroen	Xsara/ZX	9/92-	20,6
	Peugeot	306	5/93-	20,6
	Renault	19 I&II	4/91-6/96	20,6
803930	Citroen	Xsara/ZX	9/92-	20,6
	Peugeot	306	5/93-	20,6
	Renault	19 I&II	4/91-6/96	20,6
803931	Renault	Express (Rapid)	1/89-8/98	20,6
803932	Renault	Express (Rapid)	1/89-8/98	20,6
803933	Renault	20/25/30	10/75-12/93	22,0
803934	Renault	20/25/30	10/75-12/93	22,0
803935	Renault	20/25/30	10/75-12/93	23,8
803936	Renault	20/25/30	10/75-12/93	23,8
803938	Renault	Express (Rapid)	86-12/88	22,0
803940	Renault	5 Super/Clio I	6/87-3/91	20,6
803941	Renault	5 Super/Clio I	6/87-3/91	20,6
803944	Renault	21	6/87-3/91	22,0
803945	Renault	21	6/87-3/91	22,0
803946	Renault	21	4/91-	22,0
803947	Renault	21	4/91-	22,0
803948	Renault	19 I&II	1/88-6/96	20,6
803949	Renault	19 I&II	1/88-6/96	20,6
803950	Renault	Megane	11/95-	17,4
803951	Renault	Clio I	6/90-3/91	20,6
803952	Renault	Clio I	6/90-3/91	20,6
803953	Renault	Clio I	4/91-9/98	20,6
803954	Renault	Clio I	4/91-9/98	20,6
803955	Renault	19 I&II	1/88-6/96	19,0
803956	Renault	19 I&II	1/88-6/96	19,0
803957	Renault	Twingo	3/93-	20,6
803958	Renault	Twingo	3/93-	20,6
803959	Renault	Laguna	1/94-	19,0
803960	Renault	Clio II/Twingo	9/98-	17,8
803961	Renault	Laguna (Nevada)	7/86-6/95	22,0
803962	Renault	Laguna (Nevada)	7/86-6/95	22,0
803963	Renault	Kangoo	3/98-	
803964	Renault	Kangoo	3/98-	
803965	Renault	Megane	1/99-	19,0
803966	Renault	Clio II	9/98-	
803967	Renault	Clio II	9/98-	
804001	Rover Group	Rover 200/Triumph Acclaim	-9/89	19,0
804002	Rover Group	Rover 200/Triumph Acclaim	-9/89	19,0
804301	Skoda	105/120/130	8/76-10/91	19,0
804302	Skoda	Favorit/Rapid	2/83-12/92	19,0
804303	Skoda	Favorit/Felicia I-II/Felicia I-II Pick-up	1/93-	19,0
	Volkswagen	Caddy II Pick Up (9U7)	10/97-	19,0
804304	Skoda	Felicia I-II	96-6/01	20,6
	Volkswagen	Caddy II Pick Up (9U7)	10/97-	20,6
804305	Skoda	Felicia I-II Kombi/Felicia I-II Pick-up	8/95-	22,2
804306	Seat	Ibiza III (6K1)	8/99-2/02	19,0
	Skoda	Fabia	12/99-	19,0
804401	Subaru	Leone I	3/79-10/84	14,3
804507	Toyota	Corolla (KE)&(_E7_)	10/72-10/83	20,6
804522	Toyota	Corolla (AE95)/Starlet/Tercel 4WD (AL2_)	2/78-6/92	19,0

**Anvendelsesliste
Buyer's guide
Numerische Liste**



804529	Toyota	Camry/Carina II/Celica/Corolla (_E8_)&(_E9)	2/83-93	19,0
804530	Toyota	Camry/Carina II/Celica/Corolla (_E8_)&(_E9)	2/83-93	19,0
804531	Toyota	Carina II/Corolla/Corolla (_E8_)&(_E9)/Paseo/Starlet/Tercel	5/82-7/99	17,4
804532	Toyota	Carina II/Corolla/Corolla (_E8_)&(_E9)/Paseo/Starlet/Tercel	5/82-7/99	17,4
804533	Toyota	Corona/Cressida/Liteace	7/77-1/92	20,6
804534	Toyota	Dyna 100/Hiace I&II/Picnic	2/77-	20,0
804536	Toyota	Dyna 100/Hiace II&III&IV/Landcruiser		23,8
804541	Toyota	Hilux (2WD)	1/84-	22,2
	Volkswagen	Taro	4/89-3/97	22,2
804542	Toyota	Hilux (4WD)	1/87-12/89	19,0
804543	Toyota	Hilux (4WD)	8/88-	22,2
804544	Toyota	Landcruiser	2/74-12/91	25,4
804545	Toyota	Carina E/Corolla (_E10_ & _E11_)	4/92-1/02	19,0
804546	Toyota	Carina E/Corolla (_E10_ & _E11_)	4/92-1/02	19,0
804547	Toyota	Carina E/Celica	3/90-	19,0
804548	Toyota	Carina E/Celica	3/90-	19,0
804549	Toyota	Carina E	3/93-9/97	19,0
804550	Toyota	Carina E	3/93-9/97	19,0
804551	Toyota	Carina E	4/92-9/97	
804552	Toyota	Carina E	4/92-9/97	
804553	Toyota	Avensis	9/97-10/00	20,6
804554	Toyota	Avensis	9/97-10/00	20,6
804555	Toyota	Yaris	4/99-	17,46
804556	Toyota	Yaris	4/99-	17,46
804557	Toyota	Rav4 I	6/94-6/00	17,46
804701	Audi	50/80/Coupe	8/74-8/86	14,3
	Volkswagen	Derby/Golf I&II/Jetta I&II/Passat (32)/Passat Variant (33)/Polo (86)/ Polo (86C,80)/Polo Classic(86C,80)/Polo Coupe (86C,80)/ Santana (32B)/Scirocco	5/73-	14,3
804706	Audi	50/80/90/100/Coupe	8/74-	17,4
	Seat	Cordoba (6K1/C2)/Ibiza II/Ibiza III (6K1)/Toledo I	5/91-	17,4
	Volkswagen	Caddy I/Derby/Golf I&II&III/Golf III Cabrio/Golf III Variant/Golf IV Cabriolet/ Jetta I&II/Lupo (6X1,6E1)/Passat (32)&(32B)/Passat (3A2,35I)/ Passat Variant (33)/Polo/Polo Classic/Santana/Scirocco/Vento	5/73-	17,4
804707	Audi	80	72-	15,8
804709	Audi	80/100/Coupe	8/76-7/91	15,8
	Seat	Arosa	5/97-	15,8
	Volkswagen	Derby/Golf III/Passat (32B)/Polo (86C,80)/Polo (86CF)/ Polo Classic(86C,80)/Santana (32B)	10/81-	15,8
804714	Volkswagen	1200 Type I/Kaefer	1/57-7/65	22,2
804715	Volkswagen	1200 Type I/Kaefer	1/57-7/65	19,0
804716	Volkswagen	1200 Type I/1300 Type I/181/Kaefer	8/64-	22,2
804717	Volkswagen	1200 Type I/1300 Type I/1500 Type I/Kaefer	1/60-11/73	19,0
804718	Volkswagen	1200 Type I/1300 Type I/1302 Type I/1303 Type I/1500 Type I/181/Kaefer	1/60-	17,4
804719	Volkswagen	1302 Type I/1303 Type I/1500 Type 3 Kombi/Kaefer	8/64-2/76	23,8
804720	Volkswagen	1500 Type 3 Kombi/1500 Type 3 Lim./1600 Type 3	63-73	22,2
804726	Volkswagen	Transporter T1	8/63-8/70	25,0
804728	Volkswagen	Transporter T2/Transporter T3	8/68-7/92	23,8
804729	Volkswagen	LT 28 I Bus/LT 28-35 I	4/75-6/96	25,4
804731	Volkswagen	LT 28-35 I/LT 40-55 I	4/75-96	25,4
804735	Audi	80/90	9/86-7/92	19,0
	Seat	Cordoba (6K1/C2)/Ibiza III (6K1)/Ibiza IV (6L1)	6/99-	19,0
	Skoda	Octavia	9/96-	19,0

**Anvendelsesliste
Buyer's guide
Numerische Liste**



804735	Volkswagen	Derby/Golf II Syncro/Golf III/Golf III Cabrio/Golf III Variant/ Golf IV Cabriolet/Jetta II Syncro/Polo/Polo Classic (6KV2)/ Polo Variant (6KV5)/Vento	10/81-	19,0
804736	Audi	80/100	4/88-	20,6
	Skoda	Octavia	9/96-	20,6
	Volkswagen	Golf III Syncro/Passat (3A2, 35I)	2/88-4/99	20,6
804737	Volkswagen	Transporter T4	7/90-	20,6
804738	Audi	80/100	12/90-1/96	20,6
	Seat	Inca	11/95-	20,6
	Skoda	Octavia	9/96-	20,6
	Volkswagen	Caddy II (Van)/Golf III Syncro/Passat (3A2, 35I)	2/88-	20,6
804739	Audi	A2 (8Z0)	2/00-	17,4
	Seat	Arosa/Cordoba/Ibiza III (6K1)	11/93-	17,4
	Volkswagen	Golf I (Cabriolet)/Golf II/Golf III Cabrio/Golf IV Cabriolet/Lupo (6X1, 6E1)/ Passat (32)&(32B)/Polo/Polo Classic (6KV2)/Santana (32B)/Vento	5/73-	17,4
804804	Volvo	Amazon 122S, B18/Amazon Estate B18/P 121	5/59-5/71	25,4
804805	Volvo	Amazon B18/P 121	5/59-5/71	22,0
804806	Volvo	Amazon B20	9/68-70	22,2
804808	Volvo	340-360	8/75-7/91	20,6
804811	Volvo	440/460	8/88-12/96	20,6
804812	Volvo	440/460	8/88-12/96	20,6
804901	Wartburg	353	6/66-2/75	25,4
804902	Wartburg	353	6/66-2/75	25,4
804903	Wartburg	353	6/66-2/75	25,4
804904	Wartburg	353	2/75-5/91	19,05
805001	Daewoo	Matiz	9/98-	17,46
805101	Daihatsu	Charade (G10)	78-4/83	15,8
805102	Daihatsu	Charade (G10)	78-4/83	15,8
805103	Daihatsu	Charade (G 11)/Charade (G 30)	10/82-	15,8
805105	Daihatsu	Charade (G 100)&(G 101)&(G 102)&(G 200)&(G 202)&(G 203)	2/87-	17,4
805106	Daihatsu	Charade (G 100)&(G 101)&(G 102)&(G 200)&(G 202)&(G 203)	2/87-	17,4
805107	Daihatsu	Rocky	9/89-	25,4
805108	Daihatsu	Gran Move	10/96-	17,46
805109	Daihatsu	Gran Move	10/96-	17,46
805110	Daihatsu	Hijet	1/96-	17,46
805111	Daihatsu	Terios (J1)	10/97-	20,64
805112	Daihatsu	Terios (J1)	10/97-	20,64
805201	Suzuki	Swift I&II	10/83-	17,46
805202	Suzuki	Swift II	3/89-	15,87
805203	Subaru	Justy II	10/95-	17,46
805203	Suzuki	Baleno/Swift II	3/89-	17,46
805204	Subaru	Justy II	10/95-	17,46
805204	Suzuki	Baleno/Swift II	3/89-	17,46
805205	Suzuki	Alto III	9/94-6/02	17,46
805206	Suzuki	Wagon R+	2/98-5/00	15,8
805601	Porsche	924	8/75-8/85	19,0
805801	Trabant	P 601	1/66-4/90	22,2
805802	Trabant	P 601	1/66-4/90	22,2
805803	Trabant	P 601	1/66-4/90	15,87
805804	Trabant	1.1	5/90-12/91	19,05
805901	Barkas	B 1000	4/67-12/91	31,8
805902	Barkas	B 1000	4/67-12/91	31,8
805903	Barkas	B 1000	4/67-12/91	25,4
809301	Chrysler	Voyager II	1/95-3/01	17,5

Anvendelsesliste
Buyer's guide
Nummerische Liste



				\emptyset
809302	Chrysler	Voyager I	8/84-1/95	19,0
809906	Hanomag	Hanomag	-74	22,0
	MB	BM 605/606/BM 607/608		22,0
809907	Hanomag	Hanomag	73-74	22,0
	MB	BM 605/606/BM 611		22,0
809910	Citroen	LNA/Visa	11/78-	20,6
	Peugeot	104		20,6
809911	Citroen	LN/LNA/Visa	9/77-	22,0
	Peugeot	104	9/76-	22,0
	Talbot	Samba	1/81-10/86	22,0
809914	BMW	3 Series (E21)&(E30)/5 Series (E28)	6/75-12/87	19,0
	Ford	Taurus	62-64	19,0
809915	Ford	Escort I	1/68-2/76	19,0
	Rover Group	Morris Marina/Triumph Herald/Triumph Spitfire	61-80	19,0
	Triumph	Herald/Spitfire II & III	1/61-12/71	19,0
809916	Rover Group	Austin Mini MK I/Austin MK I/Rover Mini MK I	59-	19,0
	Saab	95/96	62-80	19,0
809917	Rover Group	Austin Mini MK I/Mini Cooper (MK III) (24)	64-74	16,0
	Saab	95/96	62-80	16,0
809919	Rover Group	Austin Maxi/Morris Marina	69-8/82	17,4
	Vauxhall	Firenza/Viva	70/78	17,4
809920	Ford	Capri/Escort II	12/75-86	19,0
	Volvo	340-360	8/75-7/91	19,0
809922	Ford	Escort I	1/68-2/76	19,0
	Rover Group	Morris Marina	4/71-72	19,0
809923	Ford	Escort I	1/68-2/76	19,0
	Rover Group	Morris Marina/Triumph Herald	61-72	19,0
	Triumph	Herald	1/61-12/71	19,0
809925	Bedford	CF Van	69-	22,0
	Ford	Transit	65-9/68	22,0
809926	Ford	Transit	70-86	22,2
	Rover Group	Sherpa	74-	22,2
809927	Ford Transit	70-86	22,2	
	Rover Group	Sherpa	74-	22,2
809928	Bedford	CF Van	69-	15,7
809929	Peugeot	505	8/79-12/93	20,6
	Talbot	Tagora	6/80-12/87	20,6
809930	Opel	Ascona B/Kadett C/Manta A&B	-86	19,0
	Vauxhall	Chevette	3/75-12/85	19,0
809931	Peugeot	305 II	10/82-7/90	20,6
	Talbot	1307-1510/Horizon	7/75-6/86	20,6
809932	Citroen	LN	7/76-8/77	22,2
	Peugeot	104/309 I/504/505	7/68-12/93	22,2
	Renault	11/14/5 Super/9/Express (Rapid)/18 Berline	5/76-	22,2
809933	Citroen	LN	7/76-8/77	22,2
	Peugeot	104/309 I/504/505	7/68-12/93	22,2
	Renault	11/14/5 Super/9/Express (Rapid)/18 Berline	5/76-	22,2
809934	Peugeot	306/309 II/505	8/79-7/95	20,6
	Talbot	Tagora	10/80-7/83	20,6
809935	Citroen	LN/LNA/Visa	9/77-	22,2
	Peugeot	104	9/76-	22,2
	Talbot	Samba	1/81-10/86	22,2
809936	Alfa Romeo	AR 6	9/86-12/89	25,4
	Citroen	C 25	1/83-	25,4

**Anvendelsesliste
Buyer's guide
Numerische Liste**











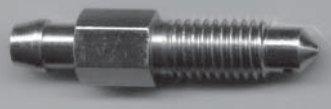
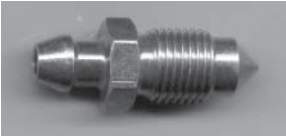

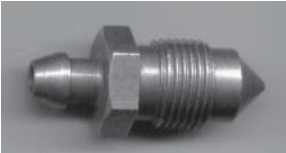

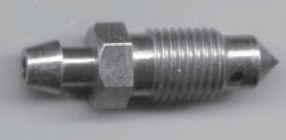
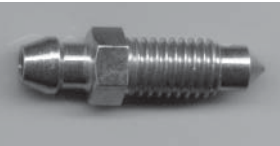

				\varnothing
809936	Fiat	Ducato	11/82-94	25,4
	Peugeot	J 5	11/82-	25,4
	Renault	Master I	8/80-7/98	25,4
809938	Daihatsu	Charmant	11/76-7/87	19,0
	Toyota	Carina/Celica/Corolla/Corolla (KE)&(_E7_)	5/73-5/88	19,0
809939	Daihatsu	Charmant	11/81-7/87	20,6
	Toyota	Corolla KE70 Van&KE76	2/80-	20,6
809940	Peugeot	305 II/405 I & II/405 I Break/405 II Break	10/82-10/96	20,6
	Talbot	1307-1510/Horizon/Rancho	7/75-6/86	20,6
809941	Peugeot	309 I	9/85-6/89	22,2
	Renault	5 Super/9/11/14/18 Berline/21/Express (Rapid)/Fuego	5/76-	22,2
809942	Peugeot	309 I	9/85-6/89	22,2
	Renault	5 Super/9/11/14/18 Berline/21/Express (Rapid)/Fuego	5/76-	22,2
809943	Citroen	C 15	10/84-12/97	22,0
	Renault	18 Berline/18 Break/Espace I&II/Fuego	2/79-	22,0
	Talbot	1307-1510/Solara	7/75-4/84	22,0
809944	Citroen	C 25	10/81-12/82	22,2
	Fiat	Ducato	11/81-10/82	22,2
	Peugeot	J 5	9/81-10/82	22,2
809945	Peugeot	309 I	10/85-7/89	17,4
	Renault	9/11	9/81-12/88	17,4
809946	Peugeot	309 I	10/85-7/89	17,4
	Renault	9/11	9/81-12/88	17,4
809947	Citroen	ZX	3/91-8/92	20,6
	Peugeot	309 II	7/89-12/93	20,6
809948	Citroen	ZX	3/91-8/92	20,6
	Peugeot	309 II	7/89-12/93	20,6
809949	Citroen	ZX/Xsara	9/92-	20,6
	Peugeot	306	5/93-	20,6
809950	Citroen	ZX/Xsara	9/92-	20,6
	Peugeot	306	5/93-	20,6
809951	Honda	Civic/Prelude I/Quintet	11/78-	17,4
	Rover Group	Rover 200/Triumph Acclaim	81-	17,4
809953	Honda	Civic/Concerto	8/89-12/95	19,0
	Rover Group	Rover 200/Rover 400 (XW)	10/89-10/95	19,0
809954	Honda	Civic/Concerto	8/89-12/95	19,0
	Rover Group	Rover 200/Rover 400 (XW)	10/89-10/95	19,0
809955	Citroen	C 25	87-	27,4
	Fiat	Ducato	9/86-94	27,4
	Peugeot	J 5	9/87-	27,4
809957	Citroen	AX/Saxo	5/91-	19,0
	Peugeot	106 I&II	9/91-	19,0
809958	Citroen	AX/Saxo	5/91-	19,0
	Peugeot	106 I&II	9/91-	19,0

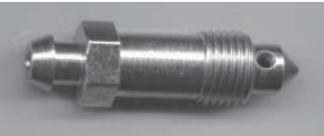
ILLUSTRATIONER UDLUFTNINGSSKRUER
 ILLUSTRATIONS BLEEDER SCREWS
 ABBILDUNGEN ENTLÜFTUNGSSCHRAUBEN

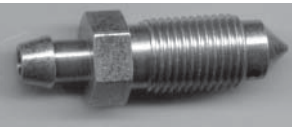











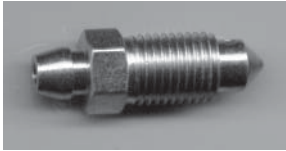

SKALA/SCALE/MÅSTAB 1:1

<p>89010</p> 	<p>M8 x 1,25 9 x 41,5</p> <p>Mercedes, Opel Vauxhall</p>	<p>89039</p> 	<p>M10 x 1 11 x 30,0</p> <p>Alfa Romeo, Citroën, Fiat, Ford, Hyundai, Mercedes, OM, Peugeot, Princess, Rover, Saab, Volvo, VW</p>
<p>89011</p> 	<p>M8 x 1,25 9 x 35,5</p> <p>Mercedes, Opel, Saab, Skoda, Vauxhall, Volvo</p>	<p>89040</p> 	<p>M12 x 1 13 x 31,4</p> <p>Ford</p>
<p>89013</p> 	<p>M6 x 1 7 x 38,0</p> <p>Audi, Subaru, VW</p>	<p>89049</p> 	<p>3/8 x 24UNF 10 x 34,0</p> <p>Ford, Hillmann, Humber, Rover, Singer, Sunbeam, Talbot (Simca), Vauxhall, Volvo</p>
<p>89015</p> 	<p>M8 x 1,25 9 x 32,4</p> <p>Citroën, Honda, Mercedes, Opel, Skoda, Vauxhall</p>	<p>89053</p> 	<p>M7 x 1 7 x 21,7</p> <p>Alfa Romeo, BMW, Citroën, Daica, Daihatsu, Ford, Isuzu, Mazda, Nissan, Peugeot, Rover, Renault, Saet, Tablot, Volvo, VW</p>
<p>89017</p> 	<p>M10 x 1 10 x 34,0</p> <p>Daihatsu, Honda, Mitsubishi, Nissan (Datsun), Rover, Subaru, Suzuki, Toyota, VW</p>	<p>89053X</p> 	<p>M7 x 1 7 x 26,2</p> <p>Alfa Romeo, BMW, Citroën, Daica, Daihatsu, Ford, Isuzu, Mazda, Nissan, Peugeot, Rover, Renault, Saet, Tablot, Volvo, VW</p>
<p>89018</p> 	<p>M10 x 1 10 x 36,5</p> <p>Fiat, Ford, OM, Rover, Talbot (Simca), Triumph, Volvo</p>	<p>89069</p> 	<p>M7 x 1 7 x 28,7</p> <p>Alfa Romeo, Ford, Mazda, Peugeot, Renault, Rover, Talbot</p>
<p>89019</p> 	<p>M10 x 1 11 x 36,0</p> <p>Ford, Toyota, VW</p>	<p>89085</p> 	<p>M8 x 1,25 9 x 49,0</p> <p>Ford, Mercedes</p>
<p>89033</p> 	<p>M6 x 1 7 x 29,0</p> <p>Audi, BMW, Saab, VW</p>	<p>89086</p> 	<p>M7 x 1 7 x 30,5</p> <p>Alfa Romeo, Audi, BMW, Citroën, DAF, Daihatsu, Fiat, Ford, Mazda, Mitsubishi, Peugeot, Renault, Saab, Subaru, Talbot, Toyota, Volvo, VW</p>

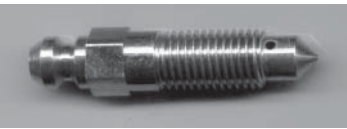
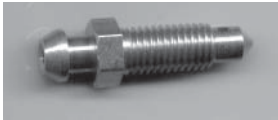
ILLUSTRATIONER UDLUFTNINGSSKRUER
 ILLUSTRATIONS BLEEDER SCREWS
 ABBILDUNGEN ENTLÜFTUNGSSCHRAUBEN

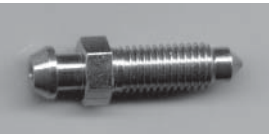

SKALA/SCALE/MÅSTAB 1:1

<p>89087</p> 	<p>M7 x 1 7 x 38,3</p> <p>Alfa Romeo, Audi, BMW, Citroën, Daihatsu, Opel, Peugeot, Subaru, Talbot, Vauxhall, Volvo, VW</p>	<p>890101</p> 	<p>M10 x 1,25 10 x 28,0</p> <p>Honda</p>
<p>89088</p> 	<p>M7 x 1 9 x 33,0</p> <p>Mercedes, Mitsubishi, Opel, Saab, Talbot, Toyota, Vauxhall</p>	<p>890105</p> 	<p>1/4" x 28UNF 7 X 28,0</p> <p>Rover, Vauxhall</p>
<p>89089</p> 	<p>M8 x 1 9 x 32,0</p> <p>Ford, Mazda</p>	<p>890107</p> 	<p>3/8 x 24UNF 10 x 31,0</p> <p>Ford, MG, Riley, Rover, Vanden Plas, Wolseley</p>
<p>89090</p> 	<p>M8 x 1 9 x 33,5</p> <p>Mazda, Opel, Vauxhall</p>	<p>890108</p> 	<p>3/8" x 24UNF 10 x 36,6</p> <p>Ford, Hillmann, Jaguar, Lotus, Morgan, Rover, Saab, Sunbeam, Talbot, Triumph, Vauxhall</p>
<p>89091</p> 	<p>M8 x 1 8 x 37,9</p> <p>Mazda</p>	<p>890120</p> 	<p>1/4" x 28UNF 8 x 28,0</p> <p>Iveco, Volvo</p>
<p>89092</p> 	<p>M8 x 1,25 8 x 34,8</p> <p>Citroën</p>	<p>890120X</p> 	<p>1/4" x 28UNF 8 x 28,0</p> <p>Special for rebuilding Volvo</p>
<p>89094</p> 	<p>M7 x 1 8 x 55,5</p> <p>Ford</p>	<p>890125</p> 	<p>Dust Cap All Bleeder Screws</p>
<p>890100</p> 	<p>M8 x 1,25 8 x 24,5</p> <p>Alfa Romeo, Autobianchi, Citroën, Fiat, Honda, Lada, Lancia, Peugeot, Polmo, Rover, seat, Talbot, Zastava</p>	<p>890126</p> 	<p>Dust Cap Special</p>

NK Autoteile Deutschland GmbH

Austrasse 10

D-99817 Eisenach

Tel.: 03691 - 257100

Fax: 03691 - 257110

www.nk-autoteile.de / www.nk-shop.de

e-mail: verkauf@nk-autoteile.de